

United States Department of the Interior  
National Park Service

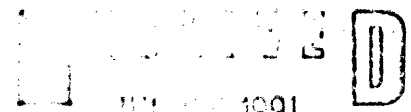

National Register of Historic Places  
Multiple Property Documentation Form

NATIONAL  
REGISTER

This form is for use in documenting multiple property groups relating to one or several historic contexts. See instructions in *Guidelines for Completing National Register Forms* (National Register Bulletin 16). Complete each item by marking "x" in the appropriate box or by entering the requested information. For additional space use continuation sheets (Form 10-900-a). Type all entries.

**A. Name of Multiple Property Listing**

Iron and Steel Resources of Pennsylvania, 1716-1945

**B. Associated Historic Contexts**

Pennsylvania Iron and Steel Industry, 1716-1945

**C. Geographical Data**

Commonwealth of Pennsylvania

See continuation sheet

**D. Certification**

As the designated authority under the National Historic Preservation Act of 1966, as amended, I hereby certify that this documentation form meets the National Register documentation standards and sets forth requirements for the listing of related properties consistent with the National Register criteria. This submission meets the procedural and professional requirements set forth in 36 CFR Part 60 and the Secretary of the Interior's Standards for Planning and Evaluation.

*Brent D. Glass*

7/3/91

Signature of certifying official

Date

Brent D. Glass Pennsylvania Historical & Museum Commission

State or Federal agency and bureau

I, hereby, certify that this multiple property documentation form has been approved by the National Register as a basis for evaluating related properties for listing in the National Register.

*Patrick Andrews*

9/5/91

Signature of the Keeper of the National Register

Date

**United States Department of the Interior  
National Park Service****National Register of Historic Places  
Continuation Sheet**

Iron and Steel Resources of Pennsylvania, 1716-1945

E 1

Section number \_\_\_\_\_ Page \_\_\_\_\_

## PREFACE

The iron and steel industry has played a critical role in the development of the United States, and Pennsylvania has been the keystone in the progress of this industry. During the eighteenth to late nineteenth century iron was used to make a vast array of goods essential to Americans, from the tools used by blacksmiths and wheel rims found on carriages to kitchen stoves and steam locomotives that traveled on iron rails. During the late nineteenth and twentieth century most products manufactured in the United States have either contained steel or been made with the aid of steel tools. The iron and steel industry has also been responsible for employing hundreds of thousands of Americans, building entire towns, and playing an important role in the rise of big business and organized labor in the United States. Pennsylvania has been widely recognized as the historical center of the nation's iron and steel industry. For over two hundred years the Commonwealth produced more iron and steel and employed more workers in this industry than any other state. Pennsylvania has also hosted more technological innovations, from the development of iron furnaces fueled by anthracite coal to the first commercially successful production of steel. In addition, the Commonwealth has been the home of some of the largest iron and steel companies in the nation.

This context addresses the technological, business and social (including labor and community) history of the iron and steel industry in Pennsylvania. Previous studies of iron and steel manufacturing have segregated these aspects of the industry's history. Paul E. Paskoff concentrates on business history in Industrial Evolution: Organization, Structure, and Growth of the Pennsylvania Iron Industry, 1750-1860. Peter Temin covers business and economic history in Iron and Steel in Nineteenth Century America: An Economic Inquiry, while David Brody focuses on social history in Steelworkers in America: The Nonunion Era. Only William T. Hogan considers business, technological and social history in his five-volume Economic History of the Iron and Steel Industry in the United States; nevertheless, he concentrates far more on business and technological history than he does on social history. This context attempts to integrate technological, business and social history into a more holistic picture of the iron and steel industry's development. In addition, this context, consistent with the mission of the Bureau for Historic Preservation as Pennsylvania's State historic Preservation Office, assimilates data gathered in field surveys of surviving iron and steel-making sites. It also places the iron and steel industry in Pennsylvania in a national context, particularly as the

**United States Department of the Interior  
National Park Service****National Register of Historic Places  
Continuation Sheet**

Iron and Steel Resources of Pennsylvania, 1716-1945

E 2

Section number \_\_\_\_\_ Page \_\_\_\_\_

Commonwealth's iron and steel industry becomes integrated increasingly in the national industry and economy.

Pennsylvania emerged as America's foremost iron producer by the mid-eighteenth century. Iron manufacturing in the Commonwealth began in 1716, with two forge operations producing crude wrought iron directly from ore. By the American Revolution iron manufacturing in Pennsylvania had grown to include almost thirty furnaces and more than fifty forges concentrated in southeastern Pennsylvania. Iron furnaces using charcoal as fuel heated iron ore and limestone to produce iron. Forges reshaped this iron into thin strips or bars that could be used by consumers such as blacksmiths. Iron furnaces and forges usually stood at the center of iron plantations, essentially rural industrial communities which supported iron workers with on-site production of foodstuffs and other commodities. Furnaces and forges generally produced iron for local markets in southeastern Pennsylvania up to the American Revolution.

Iron manufacturing expanded rapidly across much of Pennsylvania between 1784 and 1830, with the Juniata River region, and the area of the Youghigheny, Monongahela and Allegheny Rivers joining southeastern Pennsylvania as important iron-making regions. Pittsburgh in particular developed into a major market for iron, becoming a center for the developing iron rolling industry. This expansion resulted from the growth of the American economy and the spread of settlement westward beyond Pittsburgh into the Ohio and Mississippi River Valleys. Iron furnaces continued to use charcoal for fuel, relying on technology developed previously. Ironmasters also continued to build iron plantations in order to house and provide for their employees.

Pennsylvania's iron industry changed greatly between 1831 and 1866. The Commonwealth's expansion of iron production proceeded apace with the growth of the American economy, and especially the increased demand for iron rails. By 1866 Pennsylvania was producing half of all iron manufactured in the United States. Pennsylvania manufacturers extended their leadership in production through leadership in technology. Pennsylvania furnaces rapidly adopted the hot blast, which forced preheated air into the furnace, increasing the efficiency of the furnace. Eastern Pennsylvania iron manufacturers also built furnaces fueled with anthracite coal, which also improved productivity. Pennsylvania innovators developed improved methods of rolling iron, especially iron rails, and led in the integration of rolling mills with iron furnaces.

The iron industry was transformed with the nation's first commercially successful production of steel in Pennsylvania in 1867.

**United States Department of the Interior  
National Park Service****National Register of Historic Places  
Continuation Sheet**

Iron and Steel Resources of Pennsylvania, 1716-1945

E 3

Section number \_\_\_\_\_ Page \_\_\_\_\_

Between this date and 1901 capitalists erected huge steel mills in the Commonwealth that dwarfed the earlier iron furnaces and rolling mills they outmoded. These plants utilized major technological innovations, such as steel-making furnaces, continuous rolling, and integrated stages of production to manufacture a wide array of new steel products, including rails, structural shapes, plate, sheet and tubes. Business managers innovated methods of organizing and running these large-scale enterprises, consolidating more and more plants into large corporations. Pennsylvania, particularly Pittsburgh, quickly emerged as the center of the nation's developing steel industry.

Pennsylvania steel makers continued to lead the nation between 1902 and 1945. Much of the competition endemic to the earlier steel industry abated as huge firms such as the United States Steel Corporation colluded to set prices and ensure markets for manufacturers. Steel firms generally prospered through the 1920s, especially as automobile manufacturers demanded more sheet steel. The industry suffered a tremendous economic setback during the Great Depression, however, and only slowly recovered until World War II restored demand and full capacity production. For much of the period workers remained quiescent as employers instituted welfare measures designed to maintain labor-management stability. New Deal legislation enacted during the Great Depression, however, spurred the organization of the United Steel Workers of America, the first industry-wide union that effectively challenged the power of the large steel corporations.

Thus the technological, business and social history of the iron and steel industry in Pennsylvania is a story of metamorphosis. The industry in 1945 was far different from its appearance in 1716 when the first forges were established in the Commonwealth.

**United States Department of the Interior  
National Park Service****National Register of Historic Places  
Continuation Sheet**

Iron and Steel Resources of Pennsylvania, 1716-1945

E

4

Section number \_\_\_\_\_ Page \_\_\_\_\_

---

**ANCIENT TECHNOLOGY, A PROPER TIME AND PLACE, AND EARLY  
INDUSTRIAL LEADERSHIP, 1716-1783**

The first period, 1716-1783, stretches from the founding of the colony's first iron making forges to the end of the American Revolution. This period began with the initiation of iron making in Pennsylvania, two forge operations producing crude wrought iron directly from ore, and over its course witnessed the founding of almost 30 blast furnaces and over 50 forges. The factors contributing to the birth and development of this industry were the demand and close proximity of the Philadelphia marketplace, interruptions in the flow of iron imported from Great Britain, abundant natural resources and adoption of the iron plantation system of production. Contemporary technology for smelting or forging iron relied upon large volumes of charcoal for fuel and upon streams for water power. Each iron plantation, essentially a rural industrial community, revolved around the production needs of its furnace or forge, whose workmen were supported to an extent by on-site production or provision of foodstuffs and other commodities. Pennsylvania's iron making entrepreneurs, or "ironmasters," did not invent iron plantations, but they established them in greater numbers and degree of sophistication than was done in any other colony. Ironmasters typically formed formal partnerships to raise the capital necessary to buy large tracts of woodland and to erect the furnace and its supporting buildings. The success of the iron plantation system and the number that were founded in early eighteenth century Pennsylvania enabled the colony to emerge as America's foremost iron producer by the mid eighteenth century. By the eve of the Revolution, colonial American iron manufacturing, increasingly dominated by Pennsylvania, exceeded that of England herself, and represented an estimated one-seventh share of world-wide production. The role of Pennsylvania's iron industry in winning the American Revolution, while of considerable material contribution, was even greater in a psychological sense, in terms of the self reliance it imparted.

The requisite technology to produce iron is over three millenia old, and changed little from its origins up until the mid fourteenth century. During this period iron was produced directly by heating and manipulating semi-molten ore. As an element, iron does not occur in a pure state other than in meteoric form. However, iron ore, an aggregate of the metal occurring with a variety of different minerals, is very common. Despite its abundance, it was one of the last of the metals to be worked by ancient man. Archaeologists and metallurgists generally agree that this was because of its high smelting temperature and the need to develop special tools to handle and shape it, which could only

United States Department of the Interior  
National Park ServiceNational Register of Historic Places  
Continuation Sheet

Iron and Steel Resources of Pennsylvania, 1716-1945

E

5

Section number \_\_\_\_\_ Page \_\_\_\_\_

be done while the metal was red hot. The form of smelting operation thought to have been first used in Southwest Asia and then ancient Europe consisted of a simple stone and clay-lined hollow or hearth in the ground. The fuel used was charcoal, the product of carefully burning wood to create a relatively pure, carbonaceous substance that yielded considerable heat when ignited. Charcoal was first laid down on the surface of the lined hollow, then iron ore, covered with more charcoal. Draft for combustion was provided by hand- or foot-operated bellows located above the rim of the hollow, and down into the ore and charcoal charge through ceramic tubes. The product of these crude hearths was a spongy, semi-molten iron mass, or "bloom," that had to be lifted up out of the hollow, and worked by hammering to beat out the unmaleable mineral impurities. Roman and medieval European improvements upon this technology moved toward three goals: increasing smelting capacity; developing a means for tapping off molten mineral impurities, or "slag;" and introducing the draft through the bottom of the furnace. The result of working toward these goals by the fourteenth century, was the evolution of a stone shaft furnace, approximately fifteen feet high, that could be charged continuously and repeatedly. Known as the "Stückofen," this progenitor of the blast furnace had a much greater capacity than its ancestral smelting hearth, but still produced only semi-molten blooms.<sup>2</sup>

During the fourteenth century west European iron producers wedded several innovations that resulted in the development of the blast furnace, the first means of producing molten iron that could be tapped and cast. The most important of these innovations was the special structuring of the interior furnace shaft and the application of waterwheel power to work the bellows. Harnessing the power of stream-flow, while it henceforth tied smelting operations to streambank locations, created a steady high-pressure draft or blast, and higher furnace temperatures. The greater blast pressure could also permeate a larger charge of ore and charcoal. However, the relatively fragile structure of charcoal made it susceptible to crushing, collapsing the charge and impeding the air blast. By tapering the lower interior walls of the furnace inward, some of the weight of the charge could be supported and the furnace height and capacity increased. Below the widest interior point, or "bosh," the lowest part of the chamber was a cylindrical crucible which kept the molten iron concentrated to prevent its solidification. By about 1340 iron makers had arrived at a maximum furnace stack height of about thirty feet and a maximum bosh diameter of about ten feet. It was found that extending beyond these dimensions, although creating a greater charge capacity, would crush the charcoal, diminishing or concluding production. As long as charcoal was used for smelting fuel, furnace dimensions and capacity remained fixed. The

**United States Department of the Interior  
National Park Service****National Register of Historic Places  
Continuation Sheet**

Iron and Steel Resources of Pennsylvania, 1716-1945

Section number         <sup>E</sup> Page         <sup>6</sup>

loading or charging of blast furnaces was done manually through the top or tunnel head. To accommodate charging furnaces at increased heights, they were frequently built into banks. Limestone, was added to the charge of ore and charcoal, because it was found that it served as a flux in drawing away the mineral waste from the ore, forming molten slag which could be tapped from the furnace. The molten iron was allowed to run out of the furnace through the casting arch and into a sand and clay casting floor. From a main channel in the floor, the iron flowed into rows of short trenches, producing cast pigs, so called for their orderly resemblance to nursing piglets.

The development of the blast furnace had two primary implications for iron making-- higher production and the necessity of a secondary step, the finery forge, to convert cast pigs into useable iron. The ancient pre-furnace smelting hearth on which ore was converted into a bloom did not pass out of usage with the coming of the blast furnace. It remained in use not only among more primitive cultures, but also in Europe, where some consumers preferred its iron. Its technology was improved by raising and enlarging the hearth, and the adoption of large waterwheel-powered trip hammers to pound impurities out of the bloom, producing wrought iron. Wrought iron was not rendered entirely free of slag in these forges. However, the hammering flattened slag that did not drop from the bloom into long filaments within the metal, giving wrought iron its characteristic qualities of malleability and resiliency. These forges which produced wrought iron directly from ore came to be known as bloomery forges or "bloomeries," and they were still being used in Europe when America was colonized. While iron makers could smelt more iron at a faster rate in the blast furnace, pig iron contained from 3% to 4% carbon by volume, which made it brittle and unable to be wrought into articles by consumers such as blacksmiths. Therefore, a secondary step was required to decarburize pig iron. This was performed at a refinery forge, or "finery." Here, pig iron was twice heated and beaten, the first time into a "half-bloom," the second time into a flat, thick bar called an "ancony." Blasts of bellows air during the process served to burn away the carbon. Anconies were taken to another type of forge, known as a "chafery," where they were again heated and hammered, formed first into long bars, and then cut into lengths that were sold to blacksmiths. Since a furnace and a forge each had the same requirements of massive charcoal consumption and uninterrupted water power, practicality dictated that they not be operated in competition for the same woods and streams. Thus smelting and hammer-forging processes were usually separated.<sup>4</sup>

In Britain, from the time of the adoption of the blast furnace to America's colonization, iron makers expanded their activities across the

**United States Department of the Interior  
National Park Service****National Register of Historic Places  
Continuation Sheet**

Iron and Steel Resources of Pennsylvania, 1716-1945

E 7

Section number \_\_\_\_\_ Page \_\_\_\_\_

countryside and developed new types of facilities for working iron. Blast furnace smelting began in England in about 1490s, thereafter gradually supplanting bloomeries, but not overtaking them in the proportion of overall national production until the seventeenth century. By Queen Elizabeth's ascension in 1559, the growth and raw material consumption of iron making had progressed so far that its progress could be measured in unfavorable consequences. The price of charcoal, and of wood and wood products in general, had skyrocketed. The people of Sussex, including industrial consumers of wood, such as shipbuilders, brewers, and cloth dyers, petitioned for regulatory relief against local expansion of the iron industry. But furnace smelting made new products available. Sand-mold casting of iron directly into shapes at the furnace began around the end of the fifteenth century. Articles that were cast included fire-backs, andirons, plowshares and grave slabs. The sixteenth-century rise of British nationalism under the reign of the Tudors, fostered in part by a campaign of wars, hastened the development of British iron making. British reliance upon iron imports from the continent was not only a military concern, in terms of obtaining cannon and shot, but also extended itself to national economics, notably in regard to wire for woolcards. Wire-drawing mills were among the more important secondary facilities developed during this period for working iron into needed products. Another significant iron-working operation that was developed later, during the seventeenth century, was the slitting mill, where bar iron received from forges was cut into strips and rolled into iron rod for sale to blacksmiths, primarily for making nails.<sup>5</sup>

In founding and promoting his colony, William Penn recognized and advertised, among its many resources, those abundant for iron-smelting. In promotional pamphlets for his colony which he published in 1681 and 1685, he described the presence of good quality iron ore and extensive forests that could be utilized as smelting fuel. Since he himself held financial shares in established ironworks back in Britain, he perhaps had some knowledge to judge the quality of his colony's resources. It possessed an abundance of the requisite natural resources for iron manufacture, including, in addition to plentiful iron ore and extensive forests, frequent outcroppings of limestone, necessary as a flux to draw off impurities from the ore in the smelting process, and numerous streams to power the waterwheels of furnace bellows and forge hammers. Seventeenth and eighteenth century commentators who observed iron deposits in Pennsylvania, remarking about their extent, found them richer than those of England, and doubted whether they could ever be exhausted. Indeed, all four of the classes of iron ore now known to man are present in the State. They include, with their respective constituent of iron, magnetite, 74%; red hematite, 70%; brown hematite,



**United States Department of the Interior  
National Park Service****National Register of Historic Places  
Continuation Sheet**

Iron and Steel Resources of Pennsylvania, 1716-1945

E

8

Section number \_\_\_\_\_ Page \_\_\_\_\_

not more than 60%; and carbonate, not more than 48%. Ranging in broadly scattered deposits throughout Pennsylvania, iron ore lay both upon the surface of the ground in notable abundance when Penn founded his colony as well as in enormous subsurface deposits as yet undiscovered.<sup>6</sup>

Convinced that his colony was a proper place to make iron, William Penn initiated business contacts to attract investment. However, neither his negotiations with prominent English ironmaster Sir Ambrose Crowley, nor his granting of a liberal charter to the Free Society of Traders resulted in the establishment of ironworks in his colony. Despite abundant natural resources, a number of factors discouraged or limited iron production in early America. Previous unsuccessful attempts to smelt iron in the New England colonies and in Virginia had faced difficulties that included Indian raids, undeveloped colonial manufacturing laws, preference for English iron, a tendency of colonial entrepreneurs to expend their capital on land speculation rather than on iron production or other manufacturing, and distance from England and centers of population. In the case of the famous Hammersmith works, in Saugus, Massachusetts, operated during the 1660s and 1670s, poor management and high operating costs were the principal reasons for financial failure. American attempts to turn a profit through export to England faced high labor costs, the added cost of shipping and stiff competition from the established smelting and exporting business of such countries as Sweden and Russia. The American market for domestic iron in the seventeenth and early eighteenth centuries could only be thought of in the most local sense. The scattered pattern of coastal towns, connected by poor wagon roads and cart paths, passable in some points only at the mercy of the weather, added substantially to the delivered cost of iron, and made distance from centers of population the determining factor in both the viable location and operational scale of iron making. In other words, the dispersed (but growing) pockets of colonial demand favored closely-managed facilities of modest output.<sup>7</sup>

Despite the factors operating to restrict iron making, certain developments served to bring about its successful establishment in Pennsylvania. First was the emergence of a concentrated domestic market in southeastern Pennsylvania. William Penn's promotion of religious tolerance in admitting immigrants to Pennsylvania had brought the colony rapid population growth. Estimated at 500 persons in 1681, the colony's numbers were roughly 20,000 by 1700, 50,000 in 1720, and would continue to double over each of the next twenty-year periods. This growth swelled Philadelphia and spilled into its hinterlands. Thanks to Penn's religious tolerance, growth and concentration of population as occurred rapidly in and around Philadelphia from the turn of the eighteenth century onward, meant the development a large and stable market

**United States Department of the Interior  
National Park Service****National Register of Historic Places  
Continuation Sheet**

Iron and Steel Resources of Pennsylvania, 1716-1945

E 9

Section number \_\_\_\_\_ Page \_\_\_\_\_

relatively close to superior iron making resources. As population increased, the need for iron for utilitarian objects such as tools, nails and horseshoes, mounted steadily. Almost all of Pennsylvania's earliest iron demand was met through importation from England, which was itself importing two-thirds of its bar iron from Sweden by the beginning of the eighteenth century. However, just as demand for iron in Penn's colony was increasing, a series of turn-of-the-eighteenth century wars and disputes in Europe, including The War of the Spanish Succession, followed by a diplomatic and trade break between England and Sweden, and then destruction of Swedish iron works and mines by Russia, disrupted England's, and hence, America's supply of iron.

In 1716, in unrelated ventures, Thomas Rutter and Samuel Nutt each built and began to operate bloomery forges on opposing tributaries of the Schuylkill River, forty miles northwest of Philadelphia. Rutter was an enterprising blacksmith who had come to Penn's colony in 1682, and settled in Germantown, where by 1706 he served as chief magistrate. In the years prior to establishing his forge, he had prepared its setting by acquiring successive tracts of woodland. Samuel Nutt was a cultured, wealthy son of a baron who had purchased 1,250 acres of Pennsylvania land in advance of his emigration from Britain in 1714. Despite their different economic backgrounds, both men were devout Quakers drawn by conscience, as well as opportunity, to further themselves in Penn's "holy experiment" of religious toleration. Both men initiated iron production with bloomeries as opposed to the larger scale of blast furnaces. Rutter, Nutt, and others soon undertook the construction of blast furnaces and additional iron works in the Lower Schuylkill Valley. Within several decades Pennsylvania's Schuylkill Valley ironmasters had established the greatest concentration of iron making facilities in colonial America.

The growth of the American iron industry from about 1720 to 1775 was phenomenal, with Pennsylvania leading the way in production and the development of iron plantations. By the outbreak of war between the colonists and Britain, Americans were operating more blast furnaces and more forges than their English counterparts and producing an estimated one-seventh of the world's iron. Pennsylvania had a greater number of iron works than any other colony by the eve of the Revolution. The largest iron producer among all the colonies by mid century, Pennsylvania also stood first in export of bar iron to England by the 1760s. Arthur C. Bining recorded the establishment of 29 furnaces and 53 forges and other ironworks in Pennsylvania by the end of the American Revolution. The earliest Pennsylvania ironworks were neither as technologically complex as Hammersmith, nor as ambitiously scaled as some of the contemporary export-oriented works in Maryland and Virginia.

United States Department of the Interior  
National Park ServiceNational Register of Historic Places  
Continuation Sheet

Iron and Steel Resources of Pennsylvania, 1716-1945

E 10

Section number \_\_\_\_\_ Page \_\_\_\_\_

They initially reflected a pattern of entrepreneurs first establishing a bloomery forge, and if demand for the product would admit, expanding their operations by adding furnaces and other works, such as slitting mills. Yet even with their more modest start, Pennsylvania ironworks nonetheless came to achieve higher collective production. The colony's individual works, aptly described by Bining as "iron plantations," were industrial complexes carved out and set up in the hinterlands within market range of Philadelphia. While these self-sufficient manufacturing farms were not an exclusively Pennsylvanian invention, it was here where they developed to the greatest number and sophistication, and where they continued as a viable form through the first several decades of the nineteenth century. The organized components of the iron plantation, revolving around the operation of and disposal of products from its furnace or forge, were typically composed of an ironmaster's house, workers' housing, charcoal storage house, office, company store, sawmill, gristmill, blacksmith shop, barn and agricultural fields and meadows, and hundreds, if not thousands of acres of forestland. It might contain as well, a chapel, school, and miners', colliers', or other specialized laborers' housing. While ironmasters brought in some foodstuffs and manufactured goods for feeding and equipping their workers, and thus were not entirely self-sufficient, they generally, as an object of convenience and cost, attempted to produce as much as possible themselves.

A dependable team of workers, compensated according to the level and indispensability of their skills, was vital to the successful operation of an iron plantation. The size of the work force varied from one furnace to another, depending upon the scale of the operation. A typical workforce consisted of: at least two founders, working in twelve-hour shifts to run the furnace; several guttermen and keepers, who were assistants to the founders; an itinerant molder, employed only during brief periods to cast hollowware; fillers, who determined or mixed the charge of ore, charcoal, and flux; ore-roasters, if the iron ore required removal of sulfur; colliers, who transformed wood into charcoal; wood cutters; iron ore and limestone miners and breakers; perhaps a blacksmith, carpenter, wheelwright, mason, clerk, and miller; teamsters, carters, and haulers to transport materials; and farm labor to sow and harvest crops and manage livestock and orchards. Not all iron plantations retained all the various types of workers described above. Some drew upon local artisans or available local labor as settlement continued to encroach upon the frontier. The scale of the works and plantation determined the size of the work force needed. The molders, also known as "potters," generally commanded highest wages because of their specialized skills. Founders were usually second only to the molders. Although payment in kind or in company store credit was

**United States Department of the Interior  
National Park Service****National Register of Historic Places  
Continuation Sheet**

Iron and Steel Resources of Pennsylvania, 1716-1945

E 11

Section number \_\_\_\_\_ Page \_\_\_\_\_

typical, some forges and furnaces paid cash, others, a combination of cash and goods, or cash and credit. The arrangement at some furnaces provided that the founders or forgemasters would in turn pay their assistants. Carry over of the Old World apprentice system, use of indentured servants and the importation of skilled European colliers and furnacemen were all common practices. Germans, Englishmen, Welsh, and Scotch-Irish were the most prevalent ethnic groups among the workers; some ironmasters employed freed blacks, while others used slaves, reckoned to be doubly valuable where they could take the places of the more skilled roles; some occasionally employed native Americans.

The business organization of eighteenth century Pennsylvania iron companies was typically a formal arrangement between men acquainted through previous business dealings or who were related, often through intermarriage of their families. The interested parties signed a written contract that apportioned voting shares to each member according to his financial input to the total investment. Decisions were implemented by majority vote. A partnership provided several advantages over an individually-owned works; most obviously it allowed members to share both the start-up costs and speculative risks of the venture. It also pooled the business experiences, market contacts, and ideas of its members. These factors were certainly in demand, since the cost of establishing a works was not cheap, and profitability not assured. The cost of either establishing a new ironworks or buying an existing operation ranged from a few thousand pounds to over ten thousand. Typically, the capital that established eighteenth century Pennsylvania iron furnaces was American, often coming from Philadelphia merchants, however, a wide variety of occupations were represented among furnace shareholders. By arrangement of the contract, one shareholder might reside at the plantation and preside over day-to-day operation, or as arranged in many actual cases, a manager was hired to perform this function.

Many prominent Pennsylvanians, such as James Logan and James Wilson invested considerable money in ironworks with high expectations that were frequently disappointed. Logan's investment of 1,800 pounds toward establishing the Durham Company's ironworks in the late 1720s earned him considerable frustration, Wilson suffered losses from iron investments as well, and Benjamin Franklin, though a speculator on many levels, warned his friends away from iron. There were in fact numerous pitfalls to profitable iron production, including labor shortages, decline in the market price of iron, inability to secure credit for supplies, floods, and drunken workers. Quite a few eighteenth and nineteenth century works failed because of what seem with hindsight like incredibly poor planning: locations dependent upon low-grade iron ore or upon poor or

United States Department of the Interior  
National Park ServiceNational Register of Historic Places  
Continuation Sheet

Iron and Steel Resources of Pennsylvania, 1716-1945

E 12

Section number \_\_\_\_\_ Page \_\_\_\_\_

nonexistent transportation networks. Yet while many investors sustained losses, an iron plantation properly sited and managed was a profitable enterprise. There is evidence to show that some eighteenth century Pennsylvania iron masters or companies did business planning. Measures included keeping track of expenses, through hiring clerks to maintain furnace ledgers, and according to Paul Paskoff, through cutting expenses in the only area where that could be done, reducing unskilled wages. Also, according to Paskoff, Pennsylvania companies on the whole made a conscious decision to direct themselves to local demand, rather than rely upon less predictable overseas markets.<sup>13</sup>

Eighteenth century Pennsylvania ironmasters, the principal or executive owners who sometimes resided at their plantations can be generally characterized. They were West European in origin, English, Welsh and Irish for the most part, and in lesser numbers, German and French. A few were merchants or businessmen, yet more were not, but had to seek out such men as partners for working capital. With two exceptions (Samuel Nutt, Robert Grace), they were not members of European aristocracy, but middle-class toilers and spendthrifts: smiths, clerks, and forgemen. The man who kept the books in good order, or kept the forge productive, and worked toward the day when he might oversee his own works typified the successful ironmaster. The separate stories of Thomas Rutter, Thomas Potts and Robert Coleman are excellent cases in point. Rutter's origin as a blacksmith has already been noted. Potts, who had come from Wales as a boy, and like Rutter, lived first in Germantown and then settled on the Manatawny Creek, gave up his trade as a butcher to lease Colebrookdale Furnace in 1725. Rutter and partners had built this works, the colony's first blast furnace, in about 1720, naming it after the profitable English ironworks. Potts, as leaseholder, acted in capacity as manager for the merchant Philadelphians who held title to the furnace. He earned and saved enough money to gradually buy ownership shares in a period of consolidation from 1733 to 1742, by which year he owned two-thirds of the furnace and its land, 100 adjacent acres outright, and two-thirds of profitable Pine Forge (built by Rutter, 1725). In all this, he was abetted by his progeny and the shortcoming of Rutter's--Rutter's three sons had all died by 1735; Potts's three sons each married a Rutter granddaughter. Eldest son John worked for his father as a founder at Colebrookdale, starting in 1734, and considerably improved upon his father's success after he married Rutter's eldest granddaughter, who had also become heir to some Nutt family iron holdings. Chief among these advantages was brand-new Warwick Furnace on the French Creek. Through careful management of Warwick and judicious placement and use of relatives and their connections, John became the foremost Pennsylvania

United States Department of the Interior  
National Park ServiceNational Register of Historic Places  
Continuation Sheet

Iron and Steel Resources of Pennsylvania, 1716-1945

E 13

Section number \_\_\_\_\_ Page \_\_\_\_\_

ironmaster after mid century, the point by which the colony also reached preeminent production.<sup>14</sup>

Robert Coleman, active in Lancaster County, was a success story of the late eighteenth century. Arriving in Philadelphia as a teenager from Ireland in 1764, he worked first as a clerk at Hopewell Forge, then at Quitapahilla Forge, where he managed to save enough of his earnings to purchase a share of Salford Forge in 1773. He leased Elizabeth Furnace in 1776, just in time to begin producing ordnance for the Revolution. By the end of the century, he had acquired shares of Cornwall and Mount Hope Furnaces, and Hopewell Forge, and also built Colebrook Furnace. One of Pennsylvania's wealthiest men by this time, he was, by self-admission in retrospect, astonished by his own rate of success.<sup>15</sup>

Counterpoint to the early, mid and late eighteenth century achievements of Rutter, Potts and Coleman were the equally spectacular failures of such men as Henry William Stiegel, principal owner of Elizabeth Furnace and Charming Forge, who rose to prominence just after mid century, but through reckless overextension, plummeted to miserable poverty. By and large, however, the ironmasters were men held in local esteem and frequently appointed or voted into local offices, serving as judges, provincial assemblymen, and sheriffs. Although the first generation of ironmasters tended not to be well educated, they saw to it that their children were. They usually hired tutors to teach their young children at the iron plantations, and frequently sent them to Europe to complete their instruction. Metallurgy had not yet been developed as a science, but some iron makers such as Robert Grace and members of the Potts family took it upon themselves to learn the collective tenents and skills of minerology, mining and smelting.<sup>16</sup>

Pennsylvania ironmasters also played an important role in the coming of the American Revolution. British attempts to regulate American iron production in accordance with mercantile goals of the empire were ineffectual, and contributed to frictions between the colonists and Parliament. British politicians and nationalists wanted to throw off dependence upon unreliable foreign sources. But conflicting interests between English ironmasters who sought duties to protect their pig iron production from colonial competition, and English forge masters who wanted tariff-free supply resulted in opposed lobbying blocks in Parliament. Ineffective iron trade legislation which ultimately satisfied neither side, and was by and large ignored by the colonists anyway, nevertheless helped pad the colonists' list of grievances by the eve of the American Revolution. Many American iron makers, like their kinsmen in other enumerated trades, tended to lump

United States Department of the Interior  
National Park ServiceNational Register of Historic Places  
Continuation Sheet

Iron and Steel Resources of Pennsylvania, 1716-1945

E 14

Section number \_\_\_\_\_ Page \_\_\_\_\_

together all of the trade legislation as a grand conspiracy to keep profit-making in Britain, even if this entailed suppressing Americans' rights as Englishmen. Iron makers also helped make America economically independent of Britain. American iron production had become the match of Great Britain's, with Pennsylvania works leading the way. The relative rapidity of this critical industry's growth heralded the loosening of America's material dependence upon Britain. The confidence of self sufficiency in the manufacture of iron was of incalculable value, not only for supplying war goods, but more so for maintaining an uninterrupted supply of the mundane items to carry on agriculture and other activities of sustenance.<sup>17</sup>

The American Revolution had a much greater effect on the Pennsylvania iron industry than the industry had on the war. Although such Pennsylvania furnaces as Warwick, Reading, Cornwall, Hopewell, Durham, Codorus and Mary Ann manufactured cannon, shot, salt pans and ship ballast, the war brought upon the industry market disruption, inflated operating costs, labor shortages, and the distraction of market uncertainty. The war shut off the safety valve of selling excess bar iron in England. Some furnace operators such as Jacob Leshner reported destruction of their plantations by Continental troops carelessly securing provisions. British troops destroyed Valley Forge plantation. Ironmasters frequently sought military leave for their workers on the grounds of the indispensibility of the industry to the war effort; conversely, Washington himself complained specifically of such excusals on account of their depletion of his army. As iron, owing to its properties, was but a tertiary choice of metal for making cannon (next to brass and copper alloys), its impact upon colonial artillery was limited to heavy guns of siege and coastal defence. Iron's real contribution appears to have been as a primary material for small arms and camp articles. While the question of allegiance split such famous iron families as the Pottses, some iron makers such as Mark Bird were active in producing ordnance. Although the impact of iron manufacturing on the war was limited, neither America's readiness to fight, nor its ability to achieve independence, is conceivable without its highly developed iron industry. Nowhere was the industry more developed in eighteenth century America than in Pennsylvania.<sup>18</sup>

United States Department of the Interior  
National Park ServiceNational Register of Historic Places  
Continuation Sheet

Iron and Steel Resources of Pennsylvania, 1716-1945

E 15

Section number \_\_\_\_\_ Page \_\_\_\_\_

## ADJUSTMENT, MIGRATION AND PROGRESS, 1784-1830

In the period 1784-1830 Pennsylvania iron makers initially faced a post-war recession, but rebounded by the late 1780s to build a large number of new furnaces, as they expanded into new geographical areas of the State. Although a few ironmasters began scattered experimentation with new smelting and refining techniques which were revolutionizing iron production in Great Britain, as a group they continued to employ iron manufacturing methods of the previous period. Pennsylvania remained the foremost iron-producing state during this period, and the charcoal iron plantation continued to be the dominant form of iron making facility. The 1784-1830 period witnessed the rise of the Juniata Region as a new center of iron making, and the founding of new works further west on tributaries of the Youghiogheny, Monongahela, and Allegheny Rivers which focused on the Pittsburgh market. Pittsburgh developed into a major market for iron during this period and emerged as the state's most centralized location for the new iron rolling industry. Though not initially an iron producer, the city took its place during this period as an important iron refiner, rolling iron for such vital frontier products as axes, plows, horseshoes, nails and shovels, which helped enable the settlement of over 3 million Americans--a quarter of the country's population--beyond the Appalachian Mountains by 1830.<sup>1</sup>

In the years immediately after the Revolution, a recession descended upon the American iron industry. Pennsylvania ironmasters were particularly hard hit. The price of bar iron at Philadelphia dropped from an equivalent of \$112 per ton in 1784, to \$68 per ton in 1786, where it remained for two years. The price recovered to only \$80 per ton by decade's end. A host of causes for the recession has been identified. Principal factors included the end of war-related demand and inflated iron prices, rising production costs, and a flood of cheap foreign iron to coastal markets. The mounting cost of the labor component of production was attributable to the loss and dispersal of skilled manpower, a result of both the war and the opportunities of westward migration after it ended. The rising cost of the raw materials component of production came as a result of the exhaustion of ore beds and timber lands at some of the older and larger furnaces. At John Potts' Warwick Furnace, for example, by the end of the war, the cost of charcoal approached one-half of the total cost of production in a given week. In addition, tight credit and the inability of some ironmasters to collect debts owed to them compounded the recessionary climate for iron. Mark Bird, owner of Hopewell Furnace, Birdsboro Forge, and partner of numerous other iron-related ventures, went bankrupt during



United States Department of the Interior  
National Park ServiceNational Register of Historic Places  
Continuation Sheet

Iron and Steel Resources of Pennsylvania, 1716-1945

E

16

Section number \_\_\_\_\_ Page \_\_\_\_\_

this period. Caught financially overextended during the post-war recession, with inflated operating costs, a soft market for iron, and scarce credit, he put Hopewell up for sale in 1786. The furnace had already been idle several years, its taxes twice abated, when he pleaded to a creditor in 1785, as quoted by Joseph E. Walker, "...as my misfortune has been, as it now is, I have no money otherwise would have paid you Long since but if I was to a Been Crusified I could get none." While retrenchment best describes the overall direction of the American iron industry in the years immediately following the end of the war, limited construction of new works continued, but with entrepreneurs tending to focus upon local demand and backcountry markets.<sup>2</sup>

Economically, the 1784-1830 period was one of adjustment for Pennsylvania iron makers. Principal economic trends with which they had to contend were the competition of cheap British iron, the struggles over protective tariffs, and recurring national cycles of boom and bust. Inventions of the British industrial revolution, relative to its iron industry, substantially reduced production costs and increased capacity, allowing that nation to become a major iron exporter. English iron production, roughly equivalent to that of America's at the outset of the war, more than doubled by war's end, and when iron prices fell in England during the mid 1780s, large quantities were shipped to America, sometimes auctioned off in port. In 1785, Swedish mining engineer Samuel Gustaf Hermelin extensively toured and surveyed Pennsylvania ironworks, mines and market prices, concluding to his government that Swedish iron<sup>3</sup> could undersell Pennsylvania iron in the Philadelphia marketplace.

Recognizing their inability to produce iron as cheaply as their European counterparts, Pennsylvania ironmasters collectively lobbied with their brethren in other manufactures for protective legislation. The Pennsylvania Assembly enacted a protective tariff in 1785. Both the national tariff debates in 1789 and Alexander Hamilton and Tench Coxe's 1791 Report on Manufactures stressed the extent and importance of the American iron industry and the necessity to protect and encourage its growth. Iron and iron goods were among the commodities receiving the highest attention in the first national tariff, enacted in 1789. It clearly took form and substance from the the Pennsylvania tariff as a model. In 1794 Pennsylvania ironmasters successfully petitioned Congress to retain duties on foreign cast and bar iron, measures which remained in effect through 1812. However, the tariff's role in the prosperity that returned to the Pennsylvania iron industry, starting in the late 1780s, is difficult to measure. Also, domestic opposition to tariffs served to temper and regulate their form. The opposition came not only from iron consumers such as blacksmiths and farmers, but also

**United States Department of the Interior  
National Park Service****National Register of Historic Places  
Continuation Sheet**Iron and Steel Resources of Pennsylvania, 1716-1945  
E 17

Section number \_\_\_\_\_ Page \_\_\_\_\_

from a new development within the iron industry that occurred during the 1784-1830 period. As the consumer market grew with the expansion and population increase of the nation, more and more founders of finished iron goods opened shop, usurping the casting activity which had been common to furnaces of the previous period. By about 1820 the separate activities and interests of raw iron producers (pig, bar and rolled iron) and of iron manufacturers (pots, stoves, tools and other hardware) were discernible. The manufacturers, whose interest lay in purchasing iron, domestic or foreign, at the cheapest cost possible, began to address Congress in opposition to any tariff which served to raise its price. A succession of politically-charged national tariffs from 1794 through 1828 proved no panacea for Pennsylvania ironmasters who continued to share or suffer with swings in the national economy, including another severe recession in 1819-1820.<sup>4</sup>

Measured in terms of overall growth, the period 1783-1830 was one in which Pennsylvania's iron industry expanded widely, in terms of both the number of new works founded and the new geographic areas exploited. Pennsylvania iron makers led their counterparts in other states in rebounding from the post-Revolutionary War recession, establishing over 70 ironworks (furnaces, forges and nail slitting mills) from 1790 to 1800. The principal factors that enabled the recovery and expansion of Pennsylvania iron included rapid population growth and westward migration, the abundance of iron making resources in various areas of the State, and the emergence of the Pittsburgh market. Additional factors included the stabilizing effect of the Constitution upon business and industry, the physical barriers to transportation that protected new western works and their markets from European and eastern Pennsylvania iron, and increased demand during the War of 1812.<sup>5</sup>

Taking advantage of these developments, a new generation of ironmasters moved beyond the lower Susquehanna Valley that had defined the westward extent of iron making during the previous period, to establish charcoal iron plantations within the vast wooded interior of the State. They erected forges and furnaces along tributaries of the Juniata, Lackawanna and Youghiogheny Rivers. The Juniata Region, blessed with exceptionally pure hematite ore, was first opened to iron production with the erection of Bedford Furnace and Forge in 1785. The founding of Centre Furnace in 1791 defined a northern sub-area within the Juniata Region. The background of its founders provides a case study of some of the men who formed the new generation of western ironmasters. Centre Furnace founders John Patton and Samuel Miles were Revolutionary War Colonels who had gained experience and capital at established southeastern Pennsylvania furnaces, and who, through their wartime activities had gained knowledge of the resources of the State's

United States Department of the Interior  
National Park ServiceNational Register of Historic Places  
Continuation Sheet

Iron and Steel Resources of Pennsylvania, 1716-1945

E 18

Section number \_\_\_\_\_ Page \_\_\_\_\_

interior. The success of pioneer Juniata works in producing high-quality pig and bar iron drew other entrepreneurs to found numerous furnace and forge plantations within the Juniata region over the next several decades. The region attracted men such as Phillip Benner, Peter Schoenberger and others, who established packhorse routes to carry iron to Pittsburgh, utilized flatboats to move iron to Susquehanna Valley markets, laid out towns such as Bellefonte, and made the Juniata one of the foremost new iron-producing areas of the State.<sup>6</sup>

Farther west during the 1784-1830 period entrepreneurs developed another new region of iron making in Fayette County also based on the growing Pittsburgh market. It was the start of iron making west of the Allegheny Mountains, and was centered on furnace and forge plantations erected along tributaries of the Youghiogeny River. Fayette County ironmasters, like their counterparts in the Juniata Region focused on the Pittsburgh market. The natural barriers of distance, mountains and rivers that separated the western part of the State from the east, and the high cost and primitive state of overland transportation protected western ironmasters from the competition of iron from southeastern Pennsylvania and Europe. In the boom decade from 1790 to 1800, entrepreneurs established sixteen ironworks within Fayette County, almost a quarter of the total number of works founded within the State during these years. The first Fayette ironworks included Alliance Furnace, which manufactured cannon shot and shells for Anthony Wayne's Indian campaign, and Union Furnace, the first venture of transplanted Virginian Isaac Meason. One of the most notable of the Fayette County ironmasters, Meason lived much as did eastern Pennsylvania ironmasters. He was a prominent local gentleman farmer who served as a judge, involved himself in the operation of several area furnaces and forges, and constructed an exceptionally fine Georgian mansion.

While Fayette County was the center of southwestern iron production during the 1784-1830 period, a number of other ironworks were also established in Westmoreland County, and one each in Greene County and in Pittsburgh. The iron ore that existed in the immediate vicinity of Pittsburgh was too deeply imbedded to be profitably mined and smelted. Although not a raw iron producer, during this period, Pittsburgh began to have a considerable effect upon the Pennsylvania iron industry. In this era it emerged as the region's principal iron refiner and manufacturer of finished iron goods, and became a major entrepot to the West through its situation on the headwaters of the Ohio River. A national economic depression in the years 1819-1820 severely affected the manufacturing sector of the country's economy and had a devastating effect upon Pittsburgh's industry. After a few years, prosperity returned. Aided by tariffs in 1824 and 1828, and the demands of a

Charcoal Iron Furnace, Front View

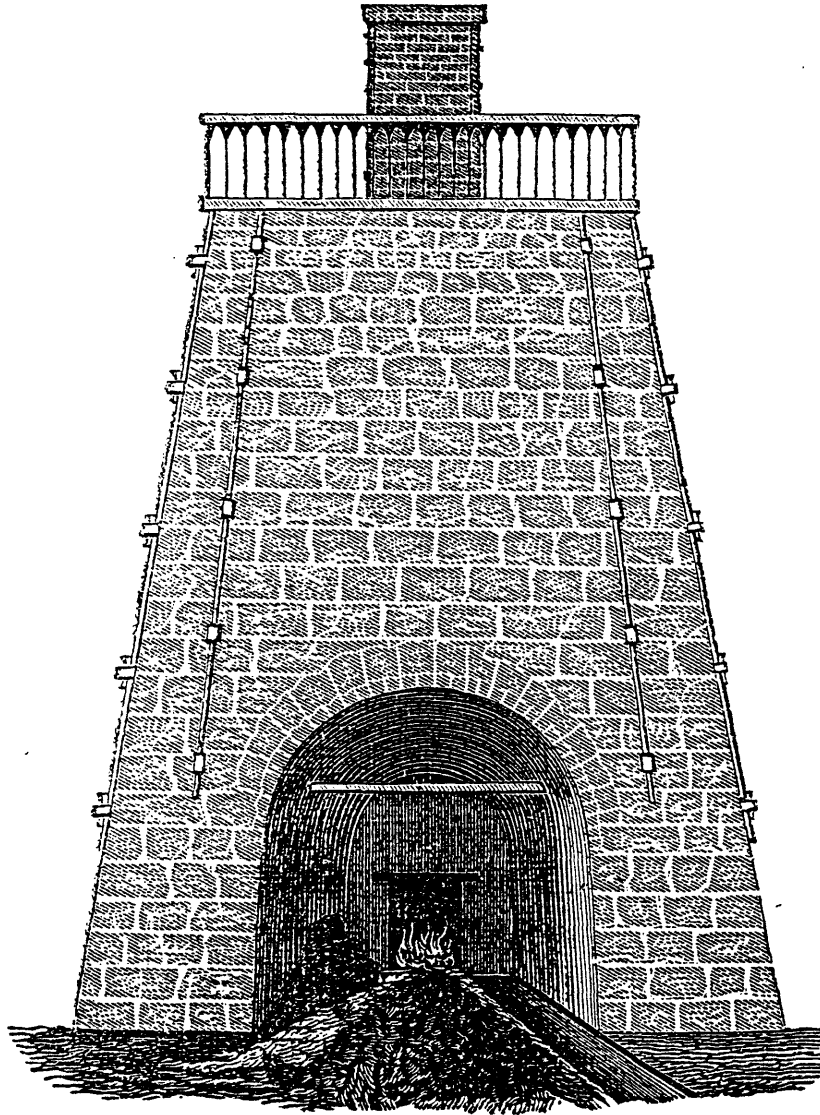

View displays the work arch or casting arch in the foreground. Vertical wrought iron binder straps reinforce the stack. Source: Frederick Overman, The Manufacture of Iron (Philadelphia: Henry C. Baird, 1854), p. 155.

Charcoal Iron Furnace, Cross-section

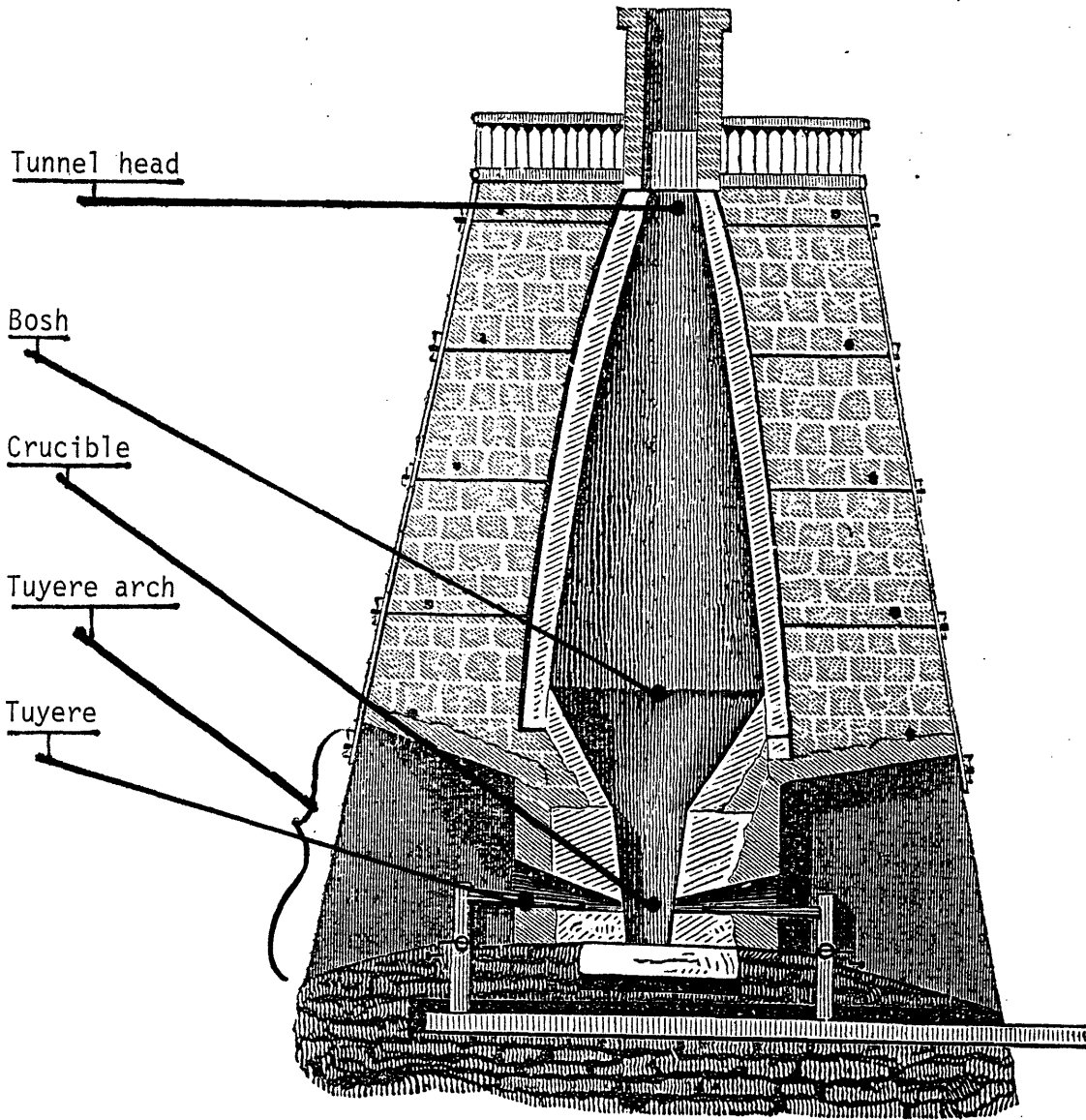

Source: Frederick Overman, The Manufacture of Iron (Philadelphia: Henry C. Baird, 1854), p. 153.

## FURNACE BLAST APPARATUS

(Sources: Arthur C. Bining, Pennsylvania Iron Manufacture in the Eighteenth Century (Harrisburg: PHMC, 1937; Frederick Overman, The Manufacture of Iron (Philadelphia: Henry C. Baird, 1854)

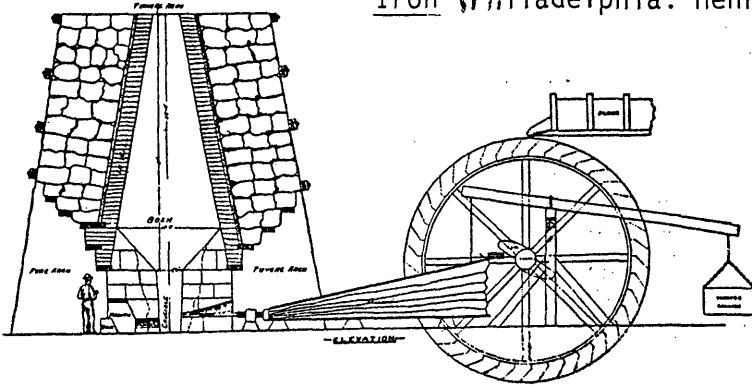

Water-powered bellows,  
18th and 19th centuries.

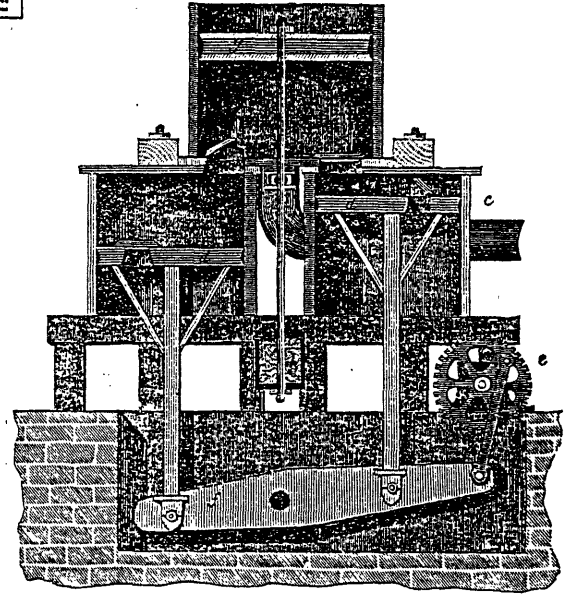

Wooden blowing tubs, introduced  
late 18th century.

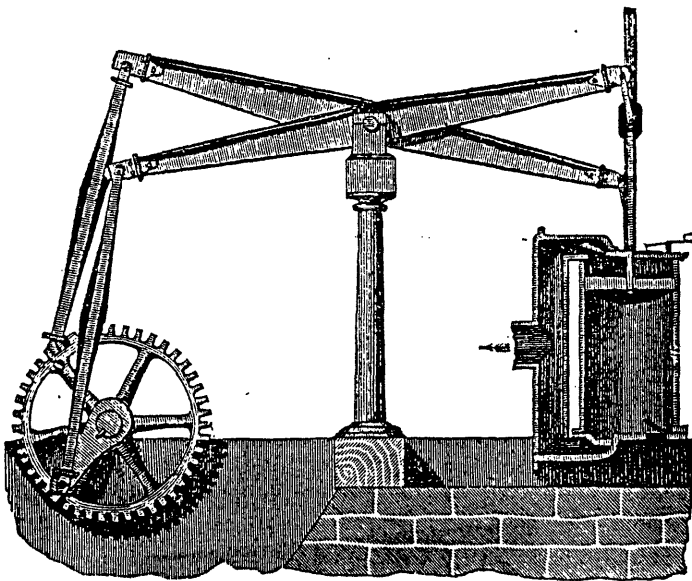

Double-stroke iron cylinder blast  
machinery, steam powered,  
19th century. Cylinder placement  
is vertical.

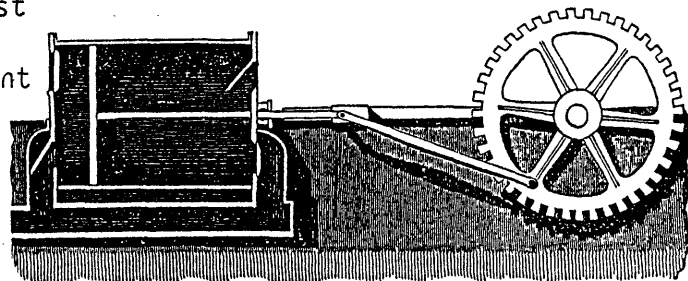

Single-stroke, horizontally placed  
iron cylinder, 19th century.

## CHARCOAL MAKING FOR IRON SMELTING

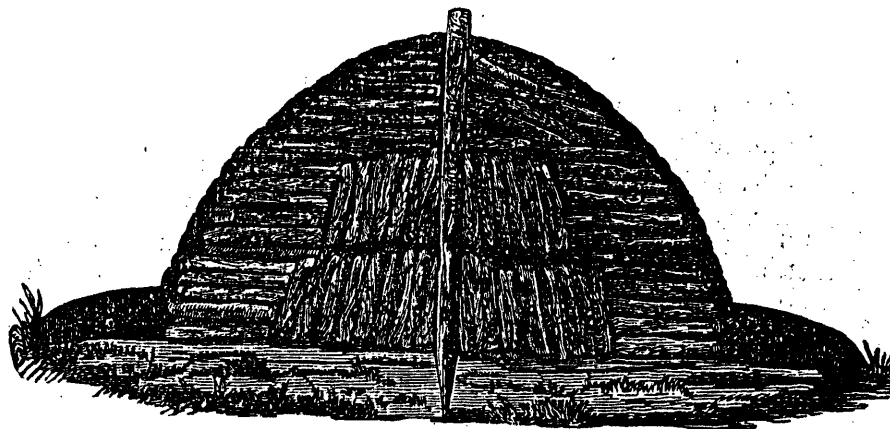

First, the lengths of wood were stacked in a particular manner.

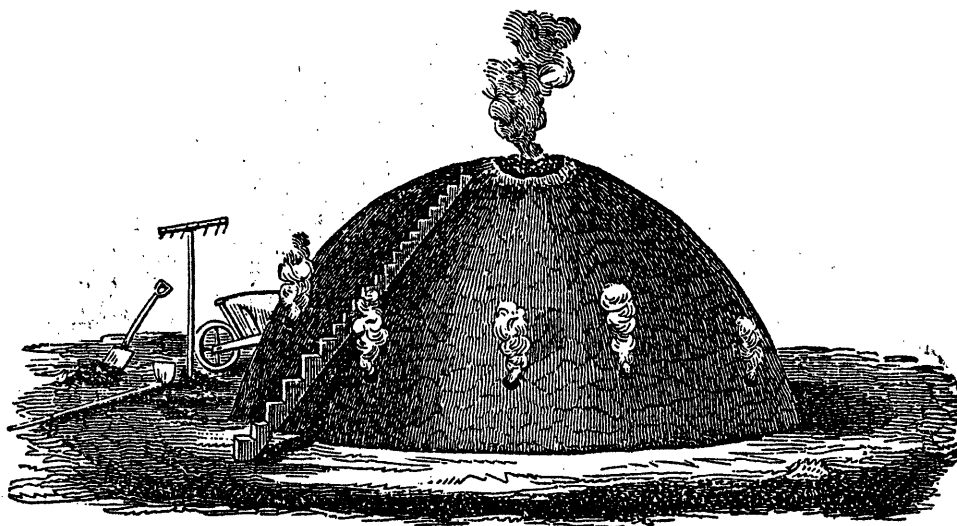

The stack of wood to be charred is covered with leaves and then dusty earth. A chimney hole and vents are created to exhaust the smoke. Source: Frederick Overman, The Manufacture of Iron (Philadelphia: Henry C. Baird, 1854), Pp. 106-107.

United States Department of the Interior  
National Park ServiceNational Register of Historic Places  
Continuation Sheet

Iron and Steel Resources of Pennsylvania, 1716-1945

E 23

Section number \_\_\_\_\_ Page \_\_\_\_\_

national population that doubled every 25 years, western Pennsylvania's iron industry saw renewed expansion. Over the decade 1820-1830 thirty-four new furnaces were built in western Pennsylvania. By the end of the 1784-1830 period Pittsburgh<sup>8</sup> industry had reached an annual consumption of 7,500 tons of iron.

In terms of technology, business organization, and labor, the character of Pennsylvania iron production during the 1784-1830 period did not change appreciably from that of the previous period. The opening of the Juniata and Fayette County regions to iron production was accomplished by replicating the successful traditional plantations of the State's southeast. The heart of the iron making process on plantations in each of these three regions throughout this era remained the charcoal-fired, water-powered stone blast furnace of traditional dimensions and capacity. The only technical furnace improvement that was widely adopted by the end of the period was the replacement of bellows with blowing tubs or cylinders. A British invention, they provided a stronger, more reliable blast. Likewise in the conduct of business, the industry remained little changed. A single owner or share partnership of two or three men provided the capital to establish furnaces and forges, and it fell to the ironmaster, if he were the sole or principal owner, or to a designated manager to attend to the daily needs of the operation.<sup>9</sup>

The most noteworthy difference in the 1784-1830 period were the hardships of opening the remote central and southwestern areas of the state to industry. Primary among concerns were the primitive state of transportation and shortage of cash and credit. Juniata Region ironmaster Phillip Benner expressed his reliance upon the pack horse train and forest trail in the late eighteenth century, noting, as quoted by Sylvester K. Stevens, "I had to pack my provisions from the Eastern Counties through the woods to supply ninety-three people."<sup>10</sup> This statement also relates the continued need for a large plantation work force. In 1801 Fayette County ironmaster John Hayden, needing credit to procure materials and provisions for the coming season of production, issued his own currency, beseeching the public in Pittsburgh newspaper advertisements to accept his notes in lieu of gold or silver, in return for supplying the frontier with iron. He appealed, as quoted by Arthur C. Bining, "I have spent upwards of a thousand nights at hand labor while others were taking their ease in bed, beating off ice from the wheels and keeping business going; my furnace blows almost without ceasing; metal can be had at all times at reasonable terms."<sup>11</sup> Thus iron making in Pennsylvania during the 1784-1830 period was pursued in continuity with established practices and attended by similar hardships and opportunities to those of the previous era. The progress of the



United States Department of the Interior  
National Park ServiceNational Register of Historic Places  
Continuation Sheet

Iron and Steel Resources of Pennsylvania, 1716-1945

E 24

Section number \_\_\_\_\_ Page \_\_\_\_\_

industry was measured in its geographic expansion, both in the establishment of new regional centers of iron making and in its westward migration which contributed materially to America's larger pattern of westward movement and settlement.

The 1784-1830 period witnessed the birth and establishment of the iron rolling industry and promising experimentation in smelting iron with anthracite coal. These activities did not widely transform the smelting of iron during this period, but did lay the groundwork for sweeping changes that would take place in the next period of development for the industry. The new British technology that had enabled its iron makers to more than double their production during the last quarter of the eighteenth century included substitution of coked coal for charcoal, refinement of pig iron in a reverberatory furnace ("puddling"), and, to complete refinement, squeezing the pastey mass of iron through grooved iron rolls. During the 1784-1830 period many Pennsylvania iron manufacturers adopted the new refining technology of puddling and rolling, but not mineral coal smelting. Among a number of reasons for their selective adoption of new techniques, the quality advantage of charcoal iron over coal-smelted iron is the most compelling. Despite its higher cost of production, the purer, more malleable product of charcoal furnaces best answered the demands of an agricultural society. The bituminous coal of western Pennsylvania, in raw form or coked, imparted embrittling sulfur and other contaminants that frustrated the skills of blacksmiths to weld and work it. In the reverberatory configuration of the puddling furnace, however, coke did not come in contact with the iron being refined, and as a result, puddling and rolling had notable success in supplanting refinery forges in the western part of the State, where bituminous coal was abundant. The puddling furnace was a box-shaped oven, clad with iron plates. Inside it had a grate for burning coke at one end, in the middle, separated from the grate by a low wall, a hearth that could be charged with pig iron through an iron door, and at the far end, a tall narrow chimney. As the pig iron became a semi-molten ball, the puddler stirred and turned it with a long-handled tool, removing it through the charging door with long-handled tongs for rolling. The grooved iron rolls were fastened one above the other in a "two-high" stand. Passing the iron through the rolls squeezed out impurities more efficiently than forge hammering had done. In addition to its advantage of cost-effectiveness, the technique of puddling and rolling iron enabled the creation of bars and later, plates, of greater length, variety of shape and dimensions, and consistency of thickness than could be achieved under the forge hammer. In 1817, Fayette County ironmaster Isaac Meason became the first in America to refine iron by the process of puddling and rolling. By 1830 a number of rolling mills had been established throughout the

**United States Department of the Interior  
National Park Service**

**National Register of Historic Places  
Continuation Sheet**

Iron and Steel Resources of Pennsylvania, 1716-1945

E 25

Section number \_\_\_\_\_ Page \_\_\_\_\_

---

State, with<sup>12</sup> the greatest concentration of mills (eight) in Pittsburgh.

In contrast to the soft coal resources of Pittsburgh, the northeastern part of the State had anthracite. A more pure, and slower and hotter-burning fuel than bituminous, anthracite was, however, harder to ignite and sustain burning. With the invention of heavier grates, anthracite could be used for puddling. During the 1784-1830 period, experimental smelting with anthracite showed enough promise for Philadelphia iron manufacturers such as nail and wire-makers Josiah White and Erskine Hazard to invest heavily in the construction of canals to access it. By 1830 the first serviceable canal network was complete. Thus, in the eastern and in the western halves of the State, based on the availability of different resources, separate courses were being charted in the future advancement of the iron industry.<sup>13</sup>

A MID-NINETEENTH CENTURY PUDDLING FURNACE

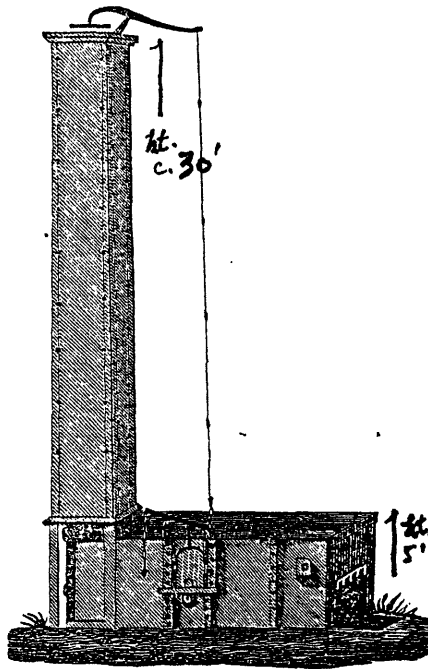

Full View  
Exterior cladding is cast iron plate.

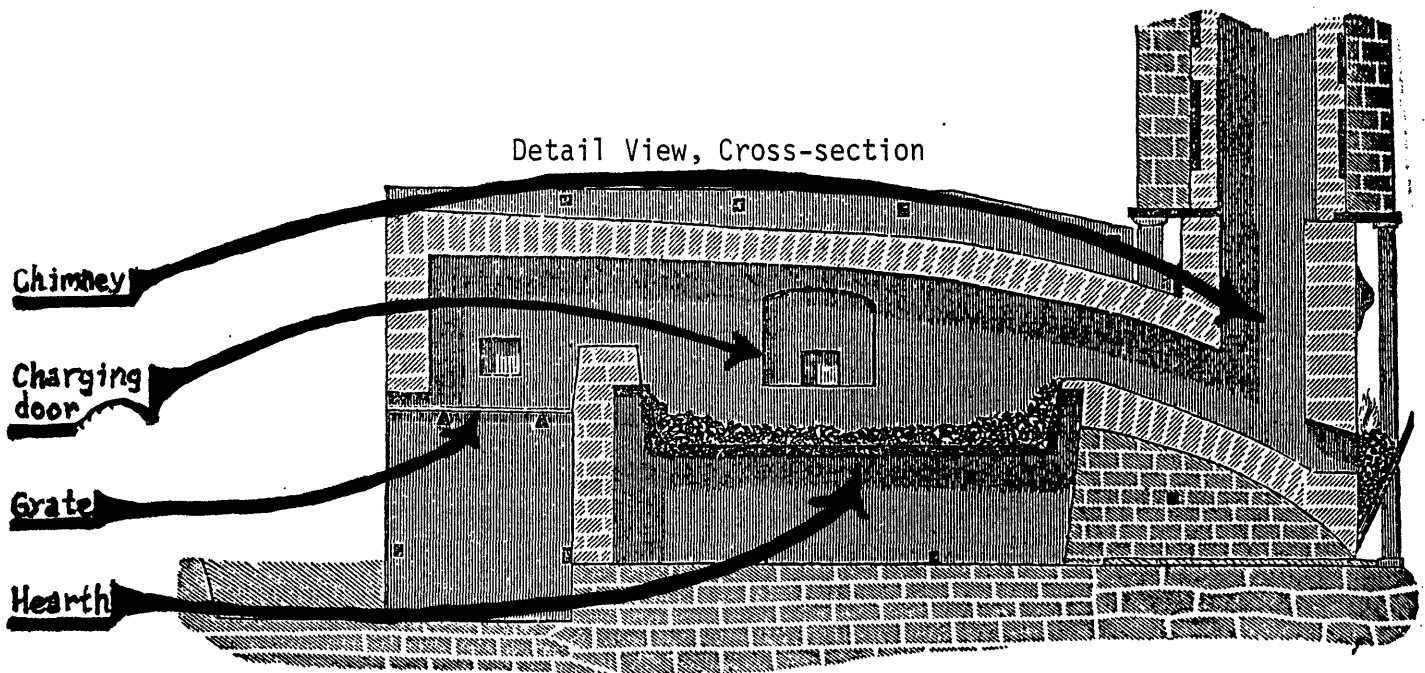

Source: Frederick Overman, The Manufacture of Iron  
(Philadelphia: Henry C. Baird, 1854), pp. 260, 264.

United States Department of the Interior  
National Park ServiceNational Register of Historic Places  
Continuation Sheet

Iron and Steel Resources of Pennsylvania, 1716-1945

E 27

Section number \_\_\_\_\_ Page \_\_\_\_\_

## MINERAL FUEL, INTEGRATION, AND SOARING PRODUCTION, 1831-1866

By the end of the Civil War, the overall production, configuration and activity of Pennsylvania iron making bore little resemblance to what its condition and character had been in 1830. Between 1831 and 1866, United States pig iron production soared from an estimated 165,000 tons to a world-leading figure of 1,206,000 tons. Pennsylvania's role in the increase was decisive as its share of national production climbed from roughly one-third to just over one-half. Over this period Pennsylvania iron makers extended their leadership in production through leadership in technology. Characterized in briefest terms, the Pennsylvania iron industry in the 1831-1866 period was driven by the new product demands of foundries and the railroad industry, and was shaped by increasing sophistication in the use of heat and adoption of mineral fuels for smelting. The period witnessed the introduction of the hot blast to smelting, accomplished initially by heating the pipe leading to the tuyeres through separate combustion, and subsequently, by reconfiguring the blast pipe over the stack tunnel head, and recycling the heat of the furnace exhaust to perform the task. The hot blast significantly improved the efficiency and speed of charcoal iron making, and enabled the substitution of anthracite coal as furnace fuel in the eastern part of the State starting in the 1840s. Gradually during the 1831-1866 period, western iron makers experimented with and slowly improved the quality of bituminous coke-smelted iron. The growing use of mineral fuels, together with the substitution of steam engines for water power, freed the industry from dependence upon factors that had, until this period favored the iron plantation system of production.

Henceforth the decentralized nature of production gradually gave way to the concentration of facilities at river or canal towns convenient for shipping and labor. While the iron rolling industry continued to expand, becoming more concentrated in Pittsburgh than in any other city, the establishment of several large rail mills in eastern Pennsylvania, made that region a national center of the rail-rolling industry. The rising demand for domestically-produced railroad rails of specified quality and affordable price sparked the founding of large rail-making firms which integrated iron smelting in their facilities. By the mid 1850s, the top five iron works in the State, which were all rail mills, each employed 1,000-3,000 men, and accounted for a disproportionately high (and growing) share of the State's total rolling mill output. While the 1831-1866 period was, on the whole, one of astounding growth for the iron industry, it continued to be affected by national economic cycles of boom and bust, typified by the growth in the

United States Department of the Interior  
National Park ServiceNational Register of Historic Places  
Continuation Sheet

Iron and Steel Resources of Pennsylvania, 1716-1945

E 28

Section number \_\_\_\_\_ Page \_\_\_\_\_

1840s and the recession by the decade's close. Ironmasters continued to exhibit their ability to close ranks during poor economic times, which they did in support of protective tariffs, most notably in a convention in Philadelphia in 1849. However, during the 1831-1866 period, a growing dichotomy between the interests of iron makers as producers, and the interests of manufacturers as iron consumers, contributed to the rise of counterbalancing sides on the issue of protective tariffs within industry, limiting the effectiveness of such conventions. Finally, the period witnessed the first substantial effort of Pennsylvania iron industry labor to unionize.<sup>2</sup>

The forms of iron demanded during the 1831-1866 period remained wrought iron and cast iron. Sectors of demand could be categorized as household goods, agricultural tools, nonagricultural equipment, construction articles, and transportation items. Household goods, including stoves and hollow ware, were predominantly castings. Construction articles, principally nails, were composed of wrought iron. The other two sectors demanded both cast and wrought iron. Agriculture, for example, required cast iron plows and edged tools. Nonagricultural equipment included steam engines, anvils and firearms. Transportation iron varied from horseshoes to wagon fittings to boat and ship articles. At the start of the 1831-1866 period wrought iron dominated the consumption ratio to cast iron, 80 percent to 20 percent. By 1850, owing to several factors, consumption of cast iron had risen, although wrought iron still led, 60 percent to 40 percent.<sup>3</sup>

Among the factors in the rise of cast iron toward the mid nineteenth century were the growth of urban foundries, made possible by the advent of economical coal-fired cupolas for remelting iron. Closer and more responsive to their consumers than in the days when founding was principally carried out at iron plantations, mid-nineteenth century foundries could produce castings of greater size, strength and intricacy. The principal products of mid-nineteenth century foundries were stoves and steam engines. Pennsylvania itself was a leading mid-nineteenth century state in both the manufacture and utilization of steam engines. The improvement of both agricultural and nonagricultural equipment also contributed to increasing demand for cast iron, as, for example, in the textile industry, where iron parts increasingly supplanted wooden components. Starting in the 1830s iron makers began to replace furnace blowing tubs with cast-iron cylinders. The development of new cast-iron products in the construction sector included iron pipes, structural iron, and storefronts. Finally, the transportation sector also contributed to the pre-1850 climb in cast iron consumption, principally in the propelling steam engines of locomotives and riverboats.<sup>4</sup>

United States Department of the Interior  
National Park ServiceNational Register of Historic Places  
Continuation Sheet

Iron and Steel Resources of Pennsylvania, 1716-1945

E 29

Section number \_\_\_\_\_ Page \_\_\_\_\_

At the start of the 1831-1866 period, the overwhelming majority of the country's wrought iron was still produced by forge hammers. Rapid expansion of the more cost-effective iron rolling industry reversed this situation, so that by 1856 the proportion of wrought iron produced by hammering to that rolled was inconsequential. After about 1850 the climbing proportional demand for cast iron to wrought iron was reversing in favor of wrought iron. The change is attributable to one product: railroad rails. Negligible in their share of American wrought iron consumption in 1831, they rose by the end of a railway boom in 1856 to constitute more than a third of the country's wrought iron consumption. However,<sup>5</sup> over half of the rails in this year were supplied by British makers.

Debate in the 1840s over whether to use wrought or cast iron for railroad rails was decided in favor of wrought iron because of its greater resilience, shock absorption and tensile strength. Initially rails were fastened upon wooden sleepers, but in disastrous failures, loosened railends curled up into "snake heads" which sometimes punched through railcar floors. To resolve this danger and better support the weight of trains, the rails were made in heavy T sections, doing away with the wooden sleepers.<sup>6</sup> However, compared to their British cousins, American iron makers were tardy in launching T rail production. In 1845 the American Railroad Journal noted, as quoted by Peter Temin, "The American iron-masters appear to consider railroad iron as unworthy of their notice. We have understood from pretty good authority that not a bar of T rail has yet been rolled in the three great anthracite and iron districts of Pennsylvania!"<sup>7</sup> The Mount Savage Rolling Mill in Maryland had rolled the first T rail in 1844. By 1846, however, there were already six U.S. mills producing T rails. The first Pennsylvania mills to roll T rail were: at Montour (in Danville, 1845); at Phoenixville (1846); at Great Western (1846, name later changed to Brady's Bend); at Lackawanna (in Scranton, 1846); at Rough-and-Ready (in Danville, 1848); and at Safe Harbor (1848). Pennsylvania had quickly dominated the fast-rising American rail industry. However, a characteristic shortcoming of American rails, in comparison with British rails was their shorter life. Owing to American mills' insufficient capacity to roll rails from single large bars of iron, they had to be built up in layers formed with smaller bars aligned in a "pile" that was heat-welded and rolled into T rail shape. The crushing weight of trains caused American rails to delaminate over time. Worn-out rails were scrapped and re-rolled without the consumption of new pig iron. By the 1860s approximately half of America's rails were being produced by re-rolling old rails.<sup>8</sup>

United States Department of the Interior  
National Park ServiceNational Register of Historic Places  
Continuation Sheet

Iron and Steel Resources of Pennsylvania, 1716-1945

E 30

Section number \_\_\_\_\_ Page \_\_\_\_\_

The 1831-1866 period witnessed fundamental changes in Pennsylvania's iron industry in terms of smelting technology, scale of setting and activity, and industrial integration. The first major technological improvement of Pennsylvania iron furnaces in the 1831-1866 period was the addition of the hot blast. Invented around 1830, in independent experiments in Britain and in America, its assets were: substantial savings in smelting costs, its inherent mechanical simplicity and relatively cheap installation cost, and its adaptability to existing (cold blast) furnaces. By heating the furnace blast, less heat and fuel were needed to smelt the iron, making the furnace more efficient. In terms of added machinery, hot-blast equipment consisted of either heating an intervening pipe between blowing cylinders and the tuyere, or, in a more economical configuration, placing the blast pipe over the stack tunnel head where combustion exhaust did the job without expending additional fuel. Today, such equipment, although rare, can be seen at Eliza Furnace (1846, Indiana/Cambria Counties), where the pipe resembles a coiled radiator configuration on top of the stack. As steam engines increasingly supplanted water power to create furnace blast, the hot furnace exhaust was also used to generate engine steam.

Growing adoption of the steam engine and the hot blast were instrumental in initiating the end of the reign of the iron plantation, and the rise of more efficient anthracite furnaces. Steam power ended dependency upon water power, and the hot blast enabled smelting with anthracite, often called "stone coal" for the difficulty of igniting it and sustaining the fire. Not only was anthracite smelting impractical before the hot blast, but use of anthracite, which better resisted crushing and air blast disintegration than charcoal, enabled the use of a taller furnace with larger capacity, and a stronger blast pressure. Stronger blast pressure in turn increased the efficiency of smelting. Thus, as Peter Temin has stated, "...the effects of the hot blast are difficult to separate from the effects of the use of mineral fuel...." Employing the hot blast and switching from charcoal to anthracite enabled iron makers to use substantially less fuel, yet smelt more iron over the same given period of time. While contemporary claims of fuel savings and product increase varied considerably from furnace to furnace, fuel savings of from 30% to 60%, and product increase of 100% typify the range of improvement.<sup>10</sup>

Hot blast technology was also adapted to charcoal smelting, particularly in eastern Pennsylvania. Statistics relative to use of the hot blast gathered at the 1849 ironmasters' convention demonstrate an even distribution in the State overall between new furnaces using the hot blast, and older furnaces to which it was converted. Convention data also show that, as of 1849, of the three iron-producing districts

# THE HOT BLAST FURNACE

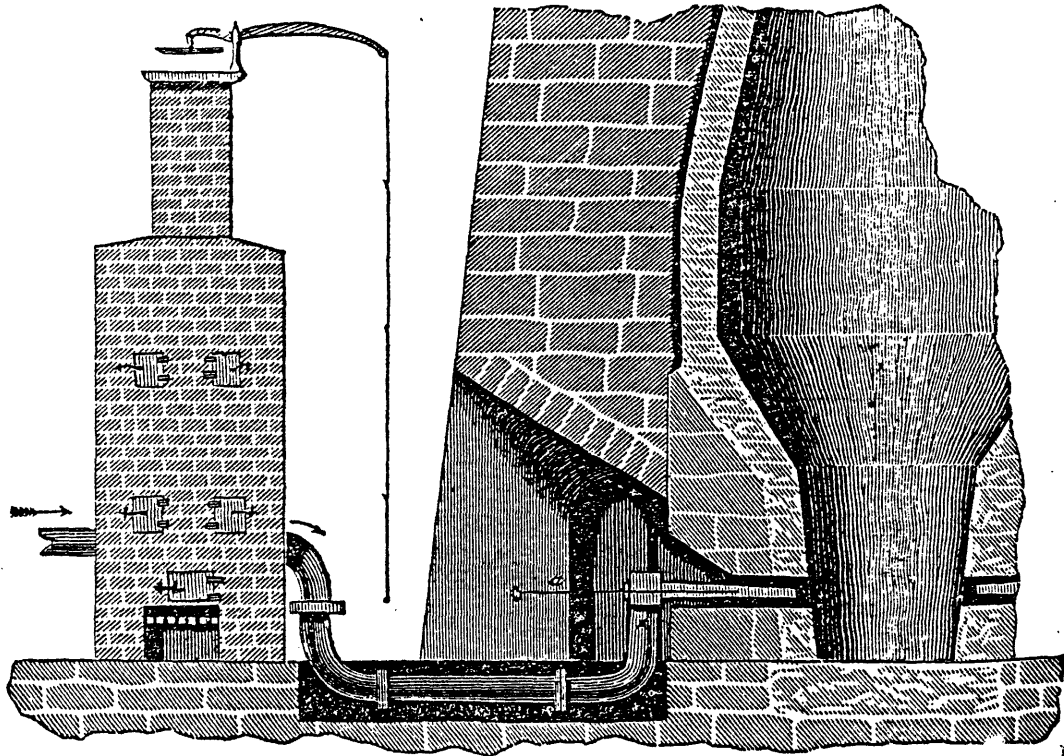

Hot blast mechanism, including stove, air pipes, tuyere, and furnace stack. Source: Frederick Overman, The Manufacture of Iron (Philadelphia: Henry C. Baird, 1854), p. 432.

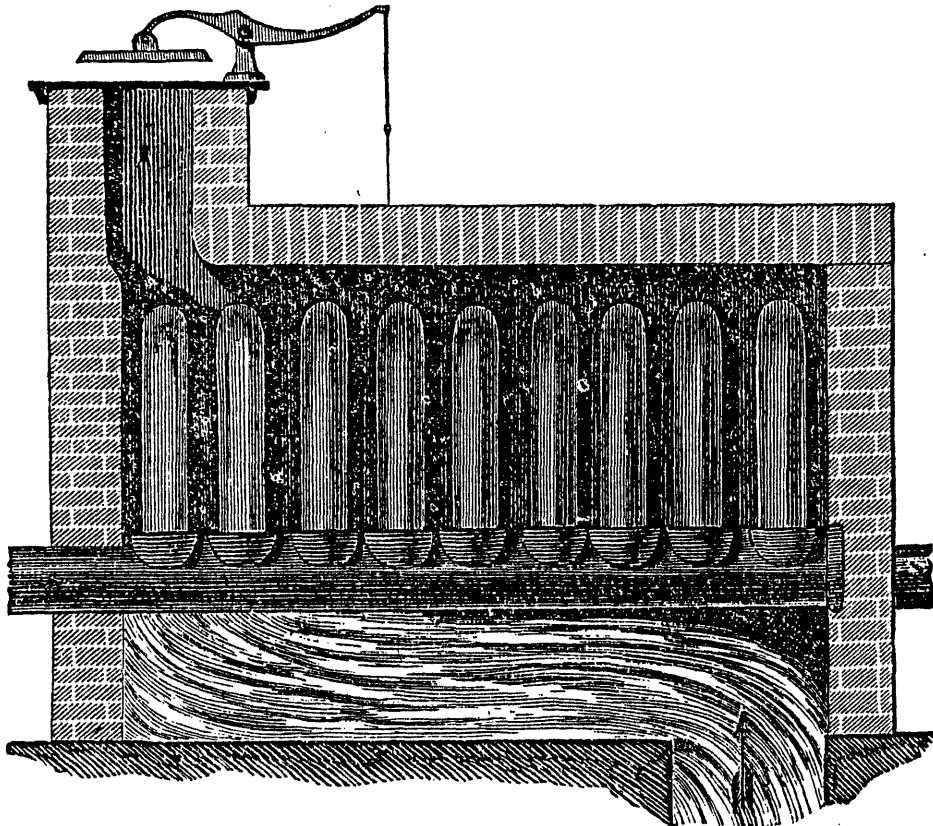

Hot blast mechanism located on top of the furnace stack to utilize waste heat. Source: Overman, p.430.



United States Department of the Interior  
National Park ServiceNational Register of Historic Places  
Continuation Sheet

Iron and Steel Resources of Pennsylvania, 1716-1945

E 32

Section number \_\_\_\_\_ Page \_\_\_\_\_

of Pennsylvania (East, Juniata Region, and West), the West was significantly behind in adopting the hot blast. While over half of the eastern and Juniata charcoal furnaces employed the hot blast by this time, only 20% did so in the West. Since adopting the hot blast did not resolve the iron-quality shortcomings associated with bituminous coal, this new technology did not have a significant effect upon the use of mineral fuel in the western part of the State.<sup>11</sup>

Despite the ability to smelt with anthracite as demonstrated in Britain and in Pennsylvania by the early years of the 1831-1866 period, the commercial success with the new fuel was not achieved until the 1840s. Once realized, however, the expansion in production grew enormously. This was largely because, as noted by Alfred Chandler, Jr., "by 1844 anthracite was the cheapest iron ever made in America."<sup>12</sup> Interest in anthracite as a manufacturing fuel began among Philadelphia industrialists when the War of 1812 had cut-off imported sources of bituminous coal. From that point, men such as nailmakers, Josiah White and Erskine Hazard began to experiment with anthracite as a manufacturing fuel in foundries and in iron smelting. In addition, the award offered by the Franklin Institute of Philadelphia during the 1820s and 1830s for sustained production of commercial grade anthracite iron, and the independent experiments of men such as Frederick Geissenhainer also advanced its introduction. However, the launching point for anthracite iron came when Welsh anthracite furnace manager David Thomas immigrated to the Lehigh Valley, imported key British blowing equipment, and built the first modern American anthracite furnace by 1840 in Catasauqua. Thomas' furnace, capitalized by White, Hazard and others, was distinguished from contemporary charcoal furnaces by its much greater height and overall size, and the large dimensions and great power of its blowing engines. The Lehigh Crane Iron Company, named after Thomas' former employer in Wales, George Crane, was an immediate success. Because of its carefully engineered construction, it produced iron almost continuously until it was dismantled in 1879. Although Crane, who owned both the British and American hot blast patents, litigated enforcement of his patent in Britain, he did not do so in America, where his design was widely copied across eastern Pennsylvania over the next few decades.<sup>13</sup>

In addition to the Lehigh Valley, other regions became centers of anthracite iron making. Scranton, in the Lackawanna Valley, became a major regional industrial center. At its peak, the Lackawanna Rolling Mill operated four contiguous anthracite furnace stacks, all of which are extant today. Within the bounds of eastern Pennsylvania accessible to the transport of anthracite, entrepreneurs developed additional facilities. By 1845, the State had 28 anthracite furnaces working, and

United States Department of the Interior  
National Park ServiceNational Register of Historic Places  
Continuation Sheet

Iron and Steel Resources of Pennsylvania, 1716-1945

E 33

Section number \_\_\_\_\_ Page \_\_\_\_\_

eight under construction. By 1849 it had 60, and by 1853, it had 121. A mid-nineteenth century cluster of anthracite iron facilities on the lower Susquehanna River provides an excellent case study of the new activity and configuration that characterized the change brought by mineral fuel. There, between Marietta and Columbia, Lancaster County, various entrepreneurs built eight anthracite furnaces between 1845 and 1868. Utilizing local iron ores, they relied upon the Pennsylvania Canal along which they situated for shipments of coal. Representing the new era of iron production facilities, these furnaces were integrated in some instances with on-site rolling mills and railroad systems, and housed their employees in dense workers' housing.<sup>14</sup>

By the close of the 1831-1866 era iron makers in Pennsylvania had largely supplanted charcoal with mineral coal, and iron plantations had given way to more highly capitalized, sophisticated plants that were established along rivers and canals at cities, or fathered their own company towns. The percentage of American pig iron made with charcoal fell from almost 100% in 1840, to 45% around 1855, and to 25% by 1866. By 1866 overall U.S. pig iron production had risen from 326,000 tons to 1,206,000 tons. From the time of the advent of anthracite smelting in the 1840s, through the Civil War, Pennsylvania's annual share of total national pig iron production exceeded 50%.<sup>15</sup>

Anthracite iron production, however, brought watershed changes to Pennsylvania iron making. The typical scale of the manufacturing facility grew, especially because of the tendency of iron companies during the 1840s boom to erect multiple furnace stacks, and the overall industry trend toward integrating rolling mills with furnace pig production. Operating more than a single stack, and attending to the additional integrated processes such as iron rolling necessitated a larger scale of industrial activity than that centered around the charcoal furnace of the previous era, and required a larger work force. Some of the old practices relative to handling of the raw materials for smelting began to change. For example, whereas the furnace charge at plantation furnaces had been measured in baskets, with the introduction of anthracite, iron makers began to measure charges by weight. With the coming of anthracite, furnace investment rose. The average capitalization of charcoal furnaces during the first half of the nineteenth century was just over \$30,000 in western Pennsylvania and over \$40,000 in eastern Pennsylvania. The adoption of anthracite signalled larger, more highly capitalized operations. Average mid-nineteenth century investment in an anthracite furnace was closer to, and may have well exceeded \$50,000. While 1850 and 1860 Census of Manufactures data must be used with caution, they strongly suggest that average investment in anthracite furnaces continued to grow in the

United States Department of the Interior  
National Park ServiceNational Register of Historic Places  
Continuation SheetIron and Steel Resources of Pennsylvania, 1716-1945  
E 34

Section number \_\_\_\_\_ Page \_\_\_\_\_

decade prior to the Civil War, but that average investment in charcoal furnaces did not.<sup>16</sup>

In comparison with developments in eastern Pennsylvania, the technical progress of mineral fuel smelting in the western half of the State during the 1830s to early 1850s was slow. This was in spite of growing adoption of coke-fueled puddling and rolling for pig iron refinement in Pittsburgh, where the number of mills more than doubled during the period, and ongoing smelting experimentation with native coal. In 1854 when the American Iron Association initiated statistical collection, the proportions of iron smelted with the fuels then in use stood at charcoal, 47.5 %; anthracite, 45%; and bituminous coal or coke, only 7.5%. The western part of the State possessed bituminous coal in substantial reserves in a broad field starting just west of the Allegheny Mountains, and extending southwest into Maryland. Bituminous coal could be used to make coke through a process of controlled burning (similar to charcoal making), which expelled gases and impurities, leaving behind a denser, carbonous product. In contrast to charcoal, coke's structure is harder, yet remains porous. As with anthracite, it has a greater ability than charcoal to resist crushing, which could impede the furnace air blast, and like anthracite, it was cheaper than charcoal to use in smelting. However, coke-smelted iron produced during the first half of the 1831-1866 period generally suffered from the impurities passed on from the fuel to the iron, and Juniata charcoal iron continued to dominate the Pittsburgh marketplace, due to its more maleable, serviceable quality.<sup>17</sup>

The first attempt to smelt with coke in Pennsylvania had been in 1819 on Bear Creek, Armstrong County, where the man responsible for erecting Isaac Meason's early puddling and rolling works superintended a coke-fired furnace which failed, due to an insufficient blast. In 1836 at Farrandsville, Clinton County, Boston entrepreneurs also failed in an attempt to utilize coke, this time because of poor quality local iron ore. The first Pennsylvania firm to enjoy even limited success with coke was the Great Western Iron Works, founded in 1846 (name changed to Brady's Bend Iron Works in 1847), which, owing to a poor grade of local coal, could not make foundry-grade iron at a profit. The company did, however, make iron sufficient to use in its own rolling mills.<sup>18</sup>

During the late 1850s and early 1860s coke was more rapidly adopted as a fuel in western Pennsylvania. By 1866, according to national statistics, bituminous and coke-smelting were used to produce 20% of all pig iron, anthracite was used for 55%, and charcoal for 25%. The quality of coke iron was improved as puddlers and cokers advanced their skills, and as the Connellsville area coal beds, which contained much of

**United States Department of the Interior  
National Park Service**

**National Register of Historic Places  
Continuation Sheet**

Iron and Steel Resources of Pennsylvania, 1716-1945  
E 35

Section number \_\_\_\_\_ Page \_\_\_\_\_

the nation's highest quality coking coal, were opened to exploitation. Coupled with improving quality of coke iron was its lower price. By 1856 coke iron was clearly cheaper than Juniata charcoal iron in the Pittsburgh market, with market rates at  $2\frac{3}{4}$ ¢ per pound for puddled coke iron and  $4\frac{1}{2}$ ¢ per pound for Juniata iron.

The advent of mineral-fuel smelting and rising wrought iron demand for rails exerted pressure upon the structure of iron making to integrate in a forward direction by further involvement in rolling iron into finished products, especially in the latter half of the 1831-1866 period. As a resulting trend, furnaces and rolling mills were established in conjunction with each other as single facilities. The old charcoal plantation structure could be described as having been integrated in a backward direction. This concept describes the fact that the ironmaster controlled his input by owning and producing the raw materials needed for his operation. The product demand, wrought iron rail, was the force that helped create forward integration as occurred at Brady's Bend. While Pittsburgh alone had over 20 rolling mills before the war, the largest iron works by 1860 were integrated rail mills, and included, in descending order of size, Montour Iron Works, Cambria Iron Works, and Phoenix Iron Company.<sup>20</sup>

Rolling mills were also supplanting the role of forges. The rate of adoption of rolling technology progressed at a faster rate than did new smelting methods. Approximately 80% of Pennsylvania's wrought iron produced in 1849 came from rolling mills. Nearly all of the forging activity at the time took place in the eastern part of the State; only three forges remained west of the Alleghenies. The greater efficiency and higher profitability of refining iron by puddling and rolling as opposed to forging it, which these statistics suggest, are confirmed by figures from the 1849 ironmasters' convention. They show that in 1849 rolling mills produced twice as much wrought iron per employee as forges, and 50% more iron per unit of capital. While just over 50% of the country's iron making establishments adopted the hot blast and mineral-fuel smelting by the mid 1850s, by this same point in time, 90% of the refining activity once performed universally at forges had been assumed by puddling and rolling operations. By 1856, 95% of the country's wrought iron was made in rolling mills.<sup>21</sup>

Pennsylvania firms and Pennsylvania industrialists played significant roles in integrating and improving the technology of mid-nineteenth century rolling mills. Highlights in the development of the State's rolling mill industry during the ante-bellum through Civil War era include John Fritz's invention of the three-high rolling mill. Railroads were frustrated in their inability to induce American

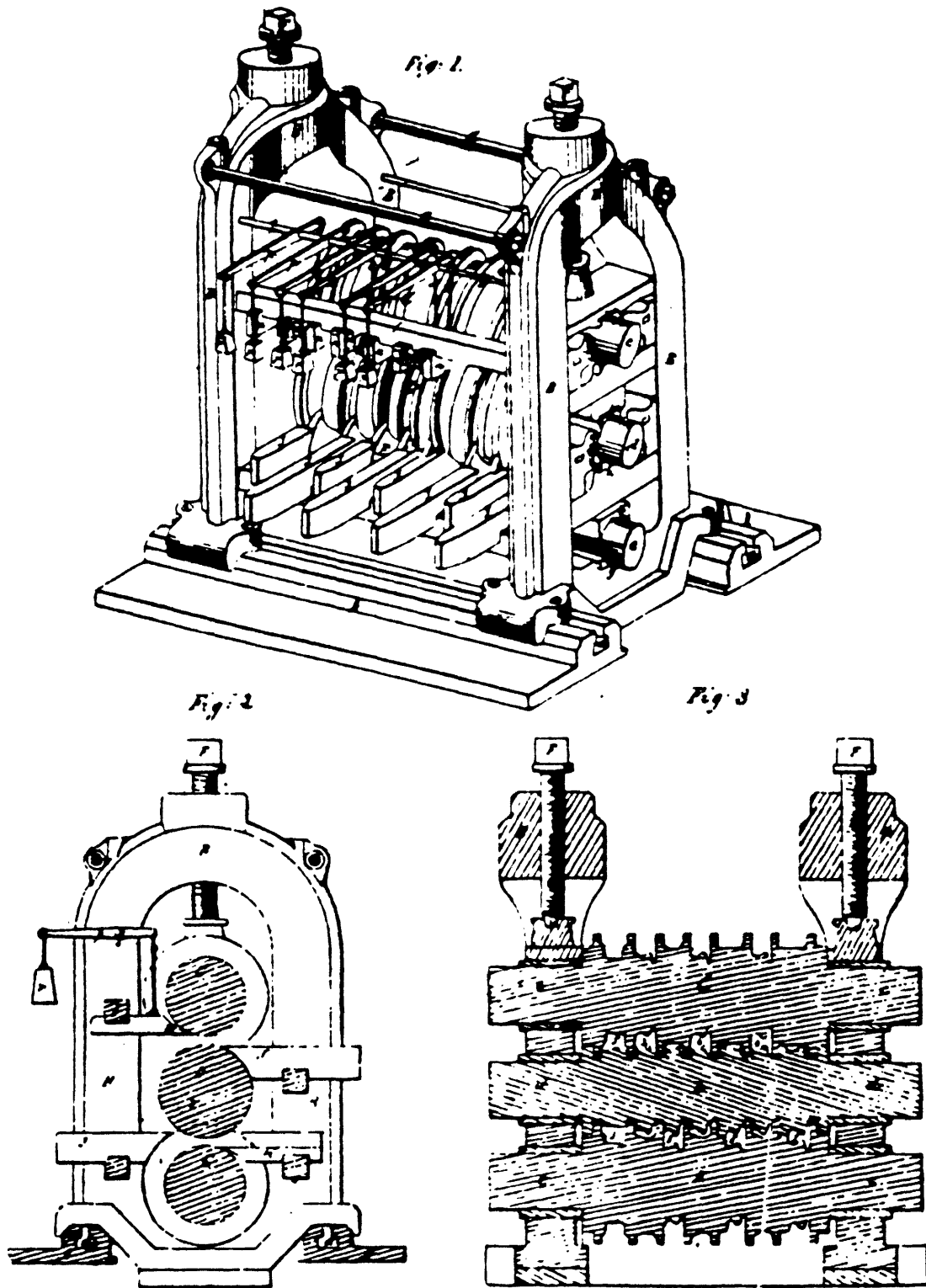
J. FRITZ.  
ROLLING RAILWAY IRON.

The three-high rail mill, invention of John Fritz of the Cambria Iron Company. It produced both a cheaper and better quality rail. (Source: Historic Resource Study, Cambria Iron Company, America's Industrial Heritage Project, National Park Service, 1989, p. 274.

## IRON ROLLING

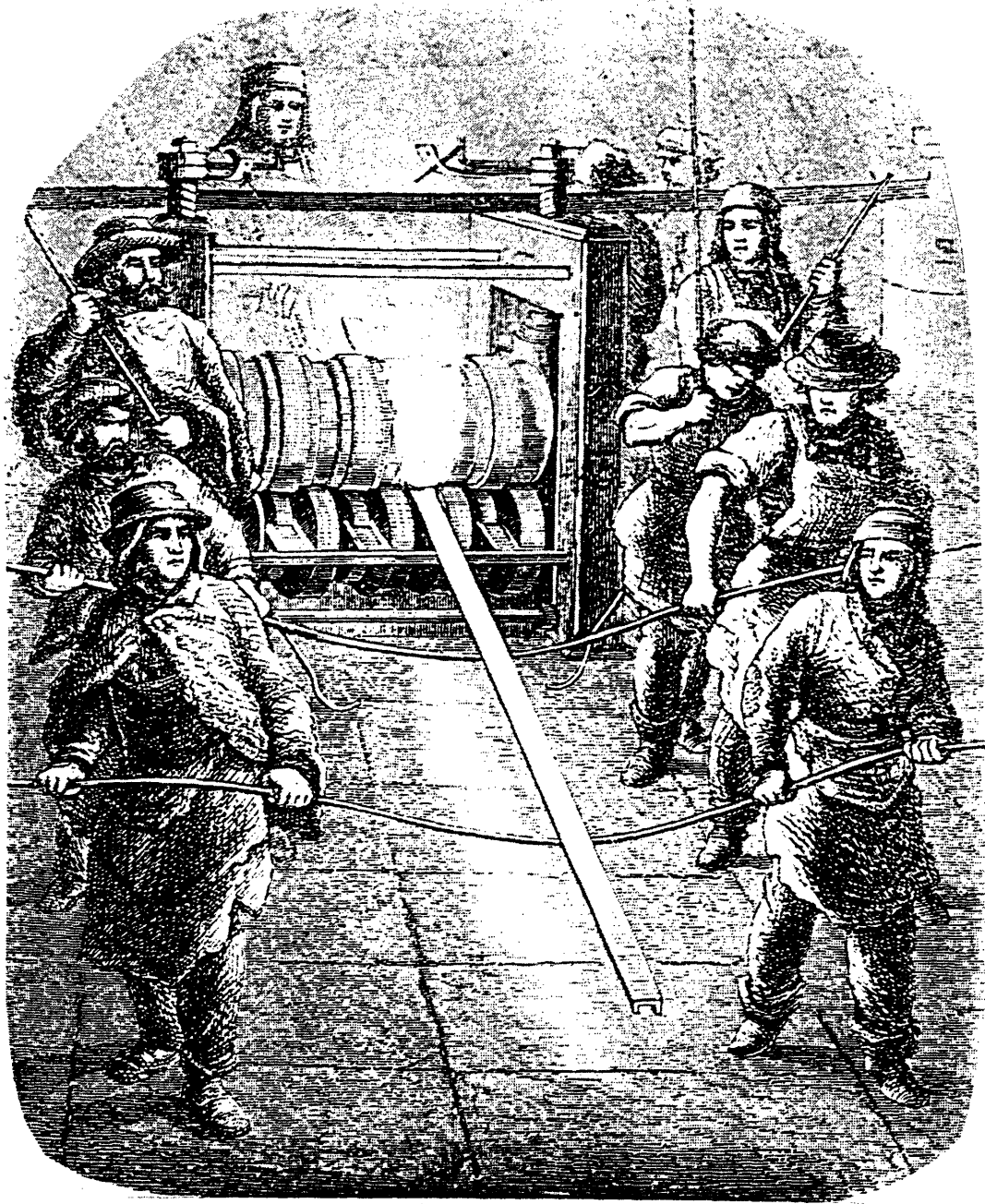

Sources: Frederick Overman, *The Manufacture of Iron* (Philadelphia: Henry C. Baird, 1854), p. 361; William T. Hogan, *Economic History of the Iron and Steel Industry in the United States*, vol. 1, Parts 1 and 2 (Lexington, Mass.: Lexington Books, 1971), p. 39.

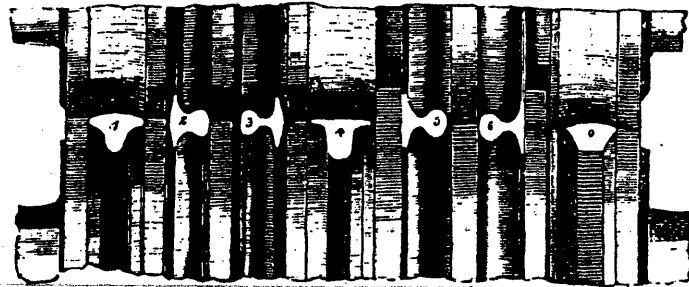

Although the workmen above are rolling a channel shape on a two-high mill, the method is identical to that of rolling railroad rails. A two-high stand for producing rails, directly above, starts with the passing of a square section iron "billet" through the rolls on the far right. Then the iron is passed successively through the rolls left to right, emerging as a rail from the #6 rolls, second from the right.

United States Department of the Interior  
National Park ServiceNational Register of Historic Places  
Continuation Sheet

Iron and Steel Resources of Pennsylvania, 1716-1945

E

38

Section number \_\_\_\_\_ Page \_\_\_\_\_

ironworks to produce affordable specified-quality rails. The rail-rolling technology at mid century consisted of manually passing a welded "pile" of iron bars between two grooved iron rolls (a two-high roll stand) turned by steam engines. The lengths of the rolls formed a progression or "train" of different groove shapes that, in the final groove formed the cross section of the finished rail or other product being rolled. Because the rolls only turned in one direction, after each pass through a groove, the rail had to be manually brought back to the original side of the rolls for the next pass. This was labor-intensive, time-consuming, and allowed the rail to cool between passes. Cooling rails often became brittle before they were finished, sometimes resulting in delamination of the bar pile from which they had been formed, requiring that they be reheated and rewelded. Sometimes the delaminating rails damaged the rolling machinery itself. While a number of technical improvements were tried, including a reversing drive for the rolls developed in British mills, the best solution was developed in 1857 by John Fritz at the Cambria Iron Works in Johnstown. Fritz applied the concept of a three-high stand of rolls, previously used in much smaller shaping processes, to the large scale of rail rolling. With this invention, a rail, following completion of a pass through the first and second rolls, could immediately be passed back (and simultaneously rolled) through the second and third rolls. The three-high rail mill enabled rollers to cut production time and to finish rails at a higher heat, which improved their quality. The three-high became a commercial success as Cambria became a rail industry leader, and by the end of the war, one-third of all American rail trains were three-high.<sup>22</sup>

The evolving business structure of iron production during the 1831-1866 period, was shaped by rising levels of capitalization required by transitions to new technologies and scales of operation, the rise of corporate management and capitalization structures, the factory scale and increased number of employees needed to operate large integrated works, and recurring national boom and bust cycles. The typical business structure at the outset of the 1831-1866 period, that of an individual or simple partnership of two or three people owning an iron producing facility, was swept aside by the huge capital requirements of the integrated firms that dominated the industry by the close of this period. During the decade of the 1850s, nearly 50% of all pig iron and over 60% of all wrought iron products came from company-owned furnaces and rolling mills. A growing concentration of the industry into fewer hands was under way. From the mid 1840s to the mid 1850s, the top five iron works (all rail mills), which represented 6% to 6½% of all rolling mills in Pennsylvania, accounted for a share of total State mill output that rose from one-quarter to one-third. Independent anthracite



An Integrated Mid-nineteenth Century Rolling Mill:  
Cambria Iron Company, 1852.

At far left are four contiguous blast furnaces. Left foreground are foundry complex and company office. The large cruciform-shaped building stretching from foreground center to right is the rolling mill. This building contained 30 puddling furnaces. At background, left, is one of two inclined planes to access the quarry and ore mines behind the facility. Center foreground is a railroad spur, and behind the buildings, hidden from view, is the Pennsylvania Canal. Source: Sharon A. Brown, *Historic Resource Study, Cambria Iron Company* (America's Industrial Heritage Project, National Park Service, 1989), pp. 203, 404-405, 422.

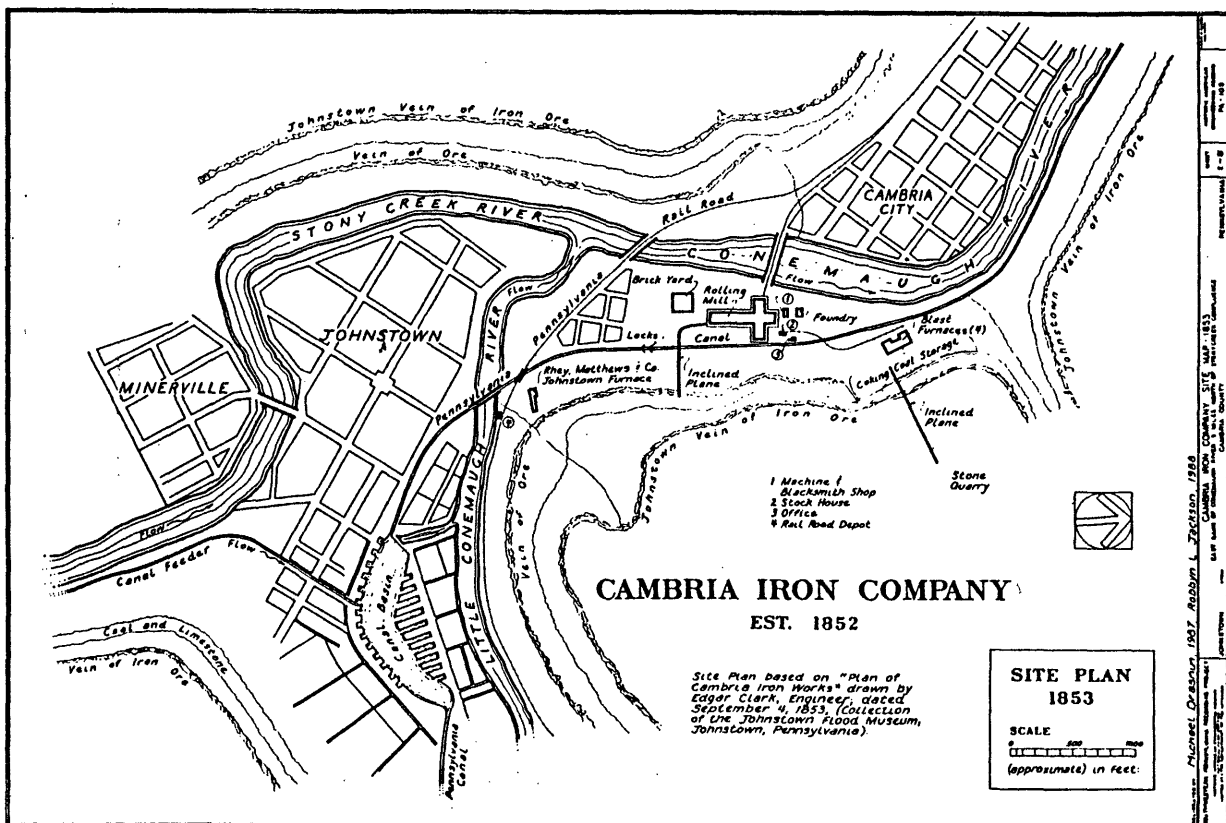



**United States Department of the Interior  
National Park Service**

**National Register of Historic Places  
Continuation Sheet**

Iron and Steel Resources of Pennsylvania, 1716-1945  
E 40

Section number \_\_\_\_\_ Page \_\_\_\_\_

---

furnaces, as noted earlier, generally required more start-up capital than had charcoal furnaces, and their structure of ownership favored company form, especially as entrepreneurs pushed construction of stack size toward the limits of technology in boom times. The charcoal furnaces that continued to operate throughout this period, characterized mostly by the western hot blast establishments, did not require significantly more capital or change in ownership structure than had charcoal furnaces of the previous 1784-1830 period.<sup>23</sup>

In the Civil War, Pennsylvania's iron production and technology were an obvious asset to the overwhelming industrial might of the northern states in supplying ordnance, naval iron, and rails. However, in terms of iron production tonnage, the war had far less impact than the mineral fuel revolutions of anthracite before the war and bituminous after. In summarizing the relationship of the war to Pennsylvania iron, the converse of Paskoff's appraisal of the American Revolution appears accurate: the Civil War had less<sup>24</sup> impact upon the iron industry than the iron industry had upon the war.

**United States Department of the Interior  
National Park Service****National Register of Historic Places  
Continuation Sheet**

Iron and Steel Resources of Pennsylvania, 1716-1945

E 41

Section number \_\_\_\_\_ Page \_\_\_\_\_

---

**THE RISE OF BIG STEEL, 1867-1901**

Capitalists, inventors and factory workers transformed the Pennsylvania iron industry between 1867 and 1901. They profoundly changed the scale, products, technology, business practices, and labor organization in the industry. Capitalists such as Andrew Carnegie greatly expanded the size of iron and steel plants in Pennsylvania, erecting huge steel mills that dwarfed the earlier iron furnaces and rolling mills they outmoded. These plants produced a wide variety of new steel products, including rails, structural shapes, wire, plate, sheet and tubes. Inventors created new technological processes, including steel-making furnaces, improved materials handling, continuous rolling, and integrated stages of production, in order to manufacture larger quantities at lower cost. Business managers innovated methods of organizing and running these mammoth enterprises, consolidating more and more plants into large corporations. Meanwhile workers developed labor unions during the 1870s to counter these powerful companies, only to have their principal union smashed during the 1890s. Throughout these manifold changes Pennsylvania, and particularly Pittsburgh, remained the center of the the nation's iron and steel industry.

The period of 1867 to 1901 began with a critical development in the evolution of the nation's iron and steel industry--the first successful, large-scale production of steel in the United States at Steelton, Pennsylvania--and ended with the creation of the largest corporation in American history--the United States Steel Corporation headquartered in Pittsburgh. Between these two milestones Pennsylvania's and the nation's iron and steel industry grew enormously. The Commonwealth's mills swelled their total output of iron and steel goods from 1,640,007 tons in 1870 to 15,290,711 tons in 1900. United States plants as a whole increased production from 3,263,585 tons in 1870 to 29,507,860 tons in 1900. National steel output burgeoned particularly quickly, surpassing iron production in 1892. This spectacular growth stemmed in large part from a rapidly expanding national market, especially for steel products. The market for iron and steel grew as railroads were built across the country, iron and steel skeletons were erected to support buildings, plates were used to make ships, and barbed wire was strung to fence in grazing land, to name just a few of the multitude of uses for iron and steel. The demand rose so quickly from the late 1860s through the 1880s that mills in Pennsylvania and other states could not expand rapidly enough to keep pace. American purchasers relied on British iron and steel imports as well as domestic production in order to meet their demands, especially during periods of economic prosperity. By 1900, however, Pennsylvania and other American manufacturers increased

**United States Department of the Interior  
National Park Service****National Register of Historic Places  
Continuation Sheet**

Iron and Steel Resources of Pennsylvania, 1716-1945

E 42

Section number \_\_\_\_\_ Page \_\_\_\_\_

production enough to meet domestic demand during prosperous times, driving out almost all British imports, and to export iron and steel during economic slumps.<sup>1</sup>

Domestic demand expanded at different rates for particular iron and steel products, leading to varying growth rates in specific manufacturing sectors of the iron and steel industry. The most rapid and important growth during the late 1860s through the early 1880s came in the manufacture of steel railroad rails. Railroad companies' demand for steel rails was the most significant factor in the beginning and expansion of the mass-production steel industry through the early 1880s. Before 1867 small quantities of steel had been made commercially in the United States by reheating wrought iron with charcoal in furnaces, thereby combining carbon with the wrought iron to produce blister steel. Pieces of blister steel were in turn melted together in small crucibles, producing small quantities of crucible steel that had a more uniform quality than blister steel. Large quantities of steel could not be manufactured until the Bessemer steel making process was introduced from Europe. British producers had begun importing Bessemer steel rails to the United States in the mid-1860s. The Pennsylvania Railroad, the largest railroad company in America, tested British Bessemer steel rails in 1863 and concluded that they were far more durable and could carry heavier trains than iron rails could. Although initially much more expensive than iron rails, the much greater durability of steel rails warranted their purchase, and American railroads quickly demanded large quantities. The Pennsylvania Railroad capitalized one half of the cost of the first plant that successfully produced Bessemer steel for rails in the United States, the Pennsylvania Steel Company at Steelton. Although the first steel ingots produced at Steelton in 1867 were rolled into rails at the Cambria Iron Works in Johnstown, by 1868 the Steelton plant had expanded to roll its own rails for the Pennsylvania Railroad. The Pennsylvania Railroad and the Pennsylvania Steel Company initiated the rapid growth in United States steel rail production.<sup>2</sup>

By 1890 Bessemer steel plants producing rails opened across Pennsylvania, often with the financial support of railroad companies. In 1871 the Cambria Iron Works began the second successful steel rail plant in Pennsylvania, adding Bessemer works to its older iron rail mill and transforming the firm into the Cambria Iron and Steel Works. The Bethlehem Iron Company also added Bessemer works to its iron rail mill in Bethlehem, beginning steel rail production in 1873. Andrew Carnegie, as head of Carnegie Brothers and Company Limited, began manufacturing steel rails at the Edgar Thomson Steel Works in 1875. This entirely new plant at Braddock, Allegheny County quickly became the largest manufacturer of steel rails in the nation. In terms of sheer output, it

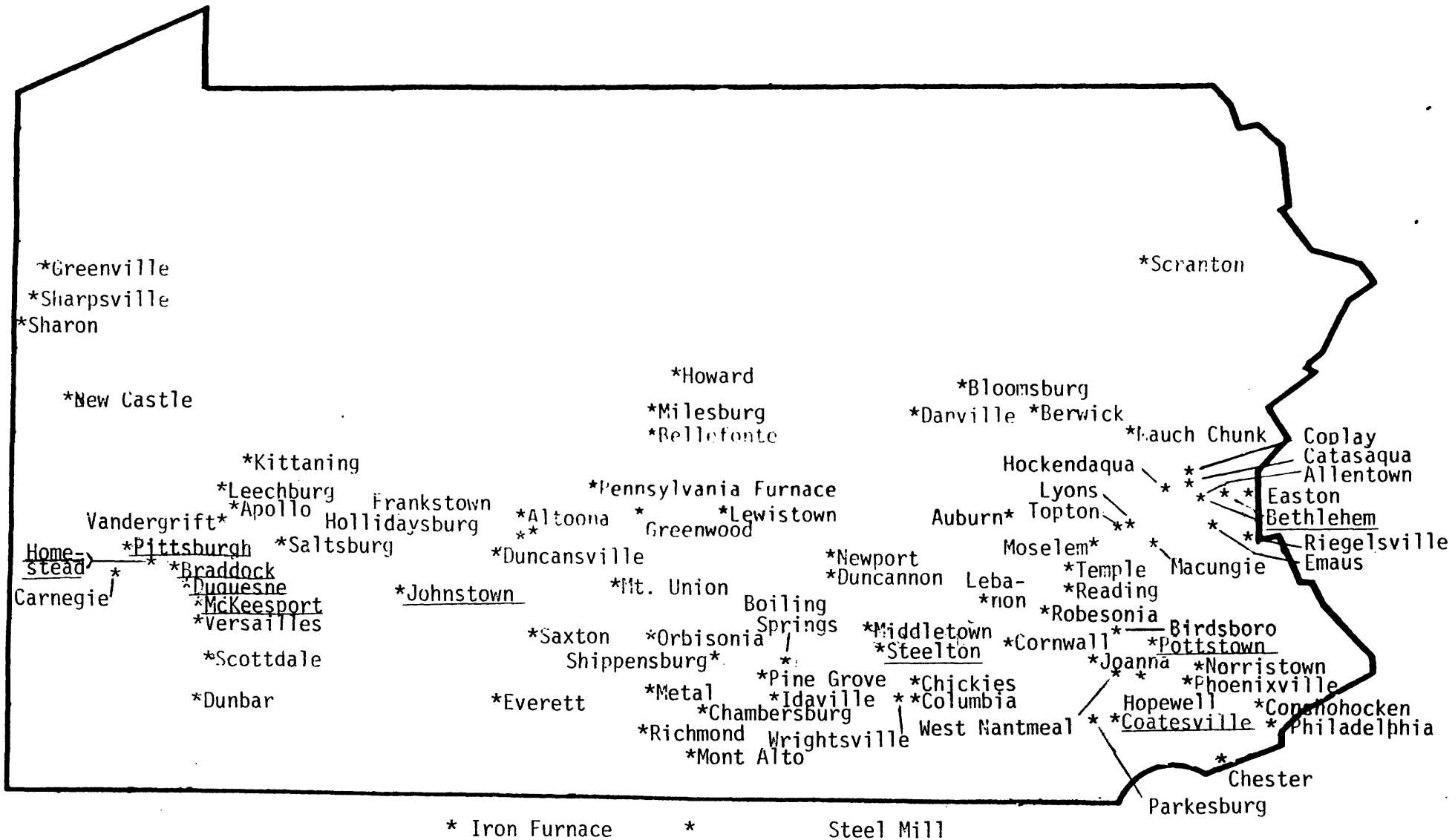

Locations of iron and steel plants in Pennsylvania, 1886. (Source: American Iron and Steel Institute, Iron and Steel Works of the United States (Philadelphia: 1886), pp. 10-31, 175-181.)

**United States Department of the Interior  
National Park Service****National Register of Historic Places  
Continuation Sheet**

Iron and Steel Resources of Pennsylvania, 1716-1945

E 44

Section number \_\_\_\_\_ Page \_\_\_\_\_

was the country's most important steel rail plant. Also in 1875 the Lackawanna Iron and Coal Company in Scranton expanded its iron rail mill to produce steel rails, creating the Lackawanna Iron and Steel Works. Other successful Bessemer plants were constructed in Ohio and Illinois; most notable were the North Chicago Rolling Mill Company begun in 1872 in Chicago and the Joliet Steel Works opened in 1873 in Joliet, Illinois, both of which became major midwestern steel rail producers. These various plants succeeded in lowering prices for steel rails until they fell below prices for iron rails in 1883, driving iron rails out of demand except for specialized uses such as light street rails. Steel rail producers also virtually ended importation of British steel rails by 1890. From 1867 to about 1890, steel rail producers dominated the country's steel industry, manufacturing over ninety per cent of the nation's total steel output in the early 1880s, and half of the steel made in 1890. Steel rail mills did not lose their dominance until the 1890s, producing just over one quarter of all steel by 1900.<sup>3</sup>

As steel rails faded from national pre-eminence, other products rose in importance, with Pennsylvania plants prominent in their manufacture. Among the most important of these products was iron and steel structural shapes. Iron structural shapes had been made for use primarily in buildings and bridges since the 1850s. The Phoenix Iron Company in Phoenixville, Chester County, Pennsylvania was the largest iron structural mill in the nation in 1867. It had developed in 1862 the Phoenix wrought iron column, composed of curved sections with flanges that were bolted together to form a column, and this column was used widely in fabricating bridges and in constructing buildings into the late nineteenth century. Steel plants produced the first steel structural shapes during the 1870s. Production of steel structural shapes superceded output of iron structural shapes during the 1880s and 1890s as consumers demanded stronger structural shapes. The foremost manufacturer of steel structural shapes in the nation during the late nineteenth century was the Homestead plant of the Carnegie Steel Company in Allegheny County. In 1883 Andrew Carnegie bought the Bessemer rail mill completed in 1881 by the Pittsburgh Steel Company. He greatly revamped the plant into a structural mill, which produced more structural steel by 1901 than any other plant in the country. Although the production of steel structural shapes in Pennsylvania and the nation grew greatly, manufacturers found them difficult to make. Structural shapes were usually made by bolting or riveting sections of iron or steel together. Structural shapes generally had to be made in small lots since the bridges and buildings they were made for varied greatly. Structural shapes also became bigger as engineers designed larger bridges with longer spans, and taller buildings in America's growing cities. Larger steel beams and columns in particular helped transform

**United States Department of the Interior  
National Park Service****National Register of Historic Places  
Continuation Sheet**

Iron and Steel Resources of Pennsylvania, 1716-1945

E 45

Section number \_\_\_\_\_ Page \_\_\_\_\_

city skylines, for "skyscrapers" based on steel skeletons rose rapidly after the first ones were erected in the 1880s.<sup>4</sup>

The wire, plate, sheet and tube sectors of the iron and steel industry also expanded rapidly, with steel again displacing iron as the predominant material in these products by the late nineteenth century. Until the late 1880s tubes used for moving oil, water and other liquids had been manufactured by welding together strips of iron called skelp. Then techniques of welding steel skelp were developed, enabling steel producers to gain just over half of the tube market by 1899. Iron and steel tubes garnered just over one tenth of the total national iron and steel output by 1899. The nation's foremost producer of iron and steel tubes was the National Tube Works, reorganized as the National Tube Company in 1899, in McKeesport, Allegheny County. Small quantities of iron wire had been made in the United States through the 1860s, but the greater strength of steel led to rapidly growing demands for steel wire. Production of steel barbed wire, invented in 1873, soared, especially as ranchers in the western United States fenced in fields and livestock. Steel wire was also made into wire nails, which were lighter and penetrated wood better than earlier iron and steel nails cut from sheets. By 1899 wire production comprised just over one tenth of the total steel made in the United States. Production of sheet, and plate which are thicker than sheet, actually declined during the 1870s as a proportion of total national iron and steel production. Yet it rose through the 1880s and 1890s to reach one fifth of total iron and steel production in 1899. As in other sectors, the great majority of plate and sheet was made of steel by 1900. Plate and sheet were used for boilers, ships, roofing and a variety of other products.<sup>5</sup>

A particular type of plate, armor, did not consume large proportions of iron and steel produced between 1867 and 1901, but it did generate considerable excitement in the industry, and at times in the federal government and press. Armor plate was a heavy product requiring exceptionally heavy machinery to manufacture it; in fact, "the capital equipment necessary to make armor plate was so heavy and costly that no one wanted to go into the business." Only Federal government contracts could adequately fund armor production, leading to a bilateral monopoly between the government and a handful of armor manufacturers. This monopoly situation helped create controversy between the government and the few suppliers over the cost and quality of armor. Among the few producers was Midvale Steel Works in Philadelphia which was one of the nation's premiere iron armor manufacturers during the 1870s. In 1887 the Bethlehem Iron Company received the first of a series of contracts to roll hardened steel for the "new navy" of larger, steel-hulled ships. The Bethlehem Iron Company replaced Midvale as the prime armor plate

United States Department of the Interior  
National Park ServiceNational Register of Historic Places  
Continuation Sheet

Iron and Steel Resources of Pennsylvania, 1716-1945

E 46

Section number \_\_\_\_\_ Page \_\_\_\_\_

manufacturer in the United States. The Carnegie Brothers and Company accepted contracts as a secondary supplier of steel armor at the urging of the Secretary of the Navy, who sought another source of armor plate.<sup>6</sup>

It took rapidly changing machinery to make armor plate and other products, particularly new steel products, between 1867 and 1901. The changing demands for iron and steel products helped spur the adoption of new technology. Capitalists' frenzy to reduce costs was also very important to fomenting new technology. Steel company owners and managers rapaciously scrapped old machinery in favor of new in order to reduce production costs. Andrew Carnegie, who was the most successful iron and steel magnate in the late nineteenth century, was well known for his determination to cut costs. Carnegie's dictum was: "Watch the costs and the profits would take care of themselves." As his biographer Joseph F. Wall emphasizes, "Construction costs never bothered Carnegie. It was the operational cost that mattered, and that simple truth was a major reason for his success." Carnegie sponsored constant improvements in machinery in his plants, which often set the pace of technological change in other iron and steel mills around the country. Charles M. Schwab, who became General Superintendent of Carnegie's Edgar Thomson Steel Works in 1889, learned well Carnegie's penchant for improving machinery. Once after Schwab had directed completion of a mill at the Edgar Thomson plant, he discovered that he could have saved fifty cents a ton more if the mill had been designed differently. After telling Carnegie of his embarrassment, Carnegie responded, "Scrap the new mill and rebuild it, it will soon pay for itself."<sup>8</sup> Schwab himself concluded that "I made up my mind to do each day something that would add to the economy or efficiency of operation."<sup>9</sup> Other iron and steel companies learned the same lesson; as the prices of steel products declined during the late nineteenth century, they assiduously adopted new machinery and scrapped old in order to cut production costs. For example, the Lackawanna Iron and Steel Works started two four-ton Bessemer converters in 1883, altered them to triple output by 1885, and six months later replaced the converters.

These rapid technological changes swept the iron and steel industry, although a dwindling number of technologically obsolete blast furnace and rolling mills continued to exist in Pennsylvania to the end of the nineteenth century. Iron and steel managers and engineers from different companies shared their technological innovations. With some notable exceptions, such as patent infringement suits filed between armor producers, firms did not restrict their own technological advances from being transferred to other iron and steel companies. Inventors and engineers also moved between companies, carrying plans for new machinery and processes with them. Alexander Holley, who was the individual most

United States Department of the Interior  
National Park ServiceNational Register of Historic Places  
Continuation Sheet

Iron and Steel Resources of Pennsylvania, 1716-1945

E 47

Section number \_\_\_\_\_ Page \_\_\_\_\_

responsible for the adoption and spread of Bessemer steel making technology in the United States, designed the large majority of Bessemer steel plants in Pennsylvania and the United States through the 1870s. He instituted the same basic designs and technological improvements in these mills, and disseminated improvements through a series of confidential technical publications he authored for managers of these plants. John Fritz, the individual most responsible for the development of the three-high roll mill at the Cambria Iron Works, brought his expertise to the Bethlehem Iron Company where he furthered technological changes as manager. Firms such as Mackintosh, Hemphill and Company, and Mesta Machine Company also constructed similar equipment for different firms in the iron and steel industry. In addition, the merger of iron and steel companies in the late nineteenth century aided the spread of technological innovations.<sup>10</sup>

The first major technological advance was the adoption of Bessemer steel production from Europe. In the 1850s Henry Bessemer of England developed a furnace that blew air through molten pig iron, heating the pig iron to a higher temperature than iron blast furnaces could achieve, and removing carbon from the iron. At one point during this process, when enough carbon was removed to reach a critical proportion of carbon, the furnace turned the molten iron into steel. However, Bessemer could not adequately control the process to consistently reach the proper proportion of carbon. Robert Mushet solved this problem by developing a process that removed all the carbon, making wrought iron, and then added the proper proportion of carbon to make steel. Between 1861 and 1865 two rival American groups obtained the United States rights to either Bessemer's or Mushet's patents, and they opened two experimental steel works in Wyandotte, Michigan and Troy, New York. Since neither group had both patents, neither was successful at consistently making large quantities of steel. Therefore, in 1866 the two groups combined their patent rights by joining together as the Pneumatic Steel Association. This firm and its successors licensed steel firms in Pennsylvania to construct and use Bessemer furnaces. Alexander Holley, who had been a member of the Troy group, designed the Bessemer plants licensed by the Pneumatic Steel Association, and until his death in 1882, improved upon the European technology he had helped bring to America.<sup>11</sup>

Holley and others greatly improved the output and per-ton cost of Bessemer works in Pennsylvania and other states. The first British Bessemer plans brought to America called for two converters facing each other across a deep pit containing ingot molds. Hard pig iron produced in a blast furnace was melted in a cupola furnace, and the molten iron was loaded into the open top of a pear-shaped Bessemer converter as it was tipped on one side. The converter was tilted upright, air was blown



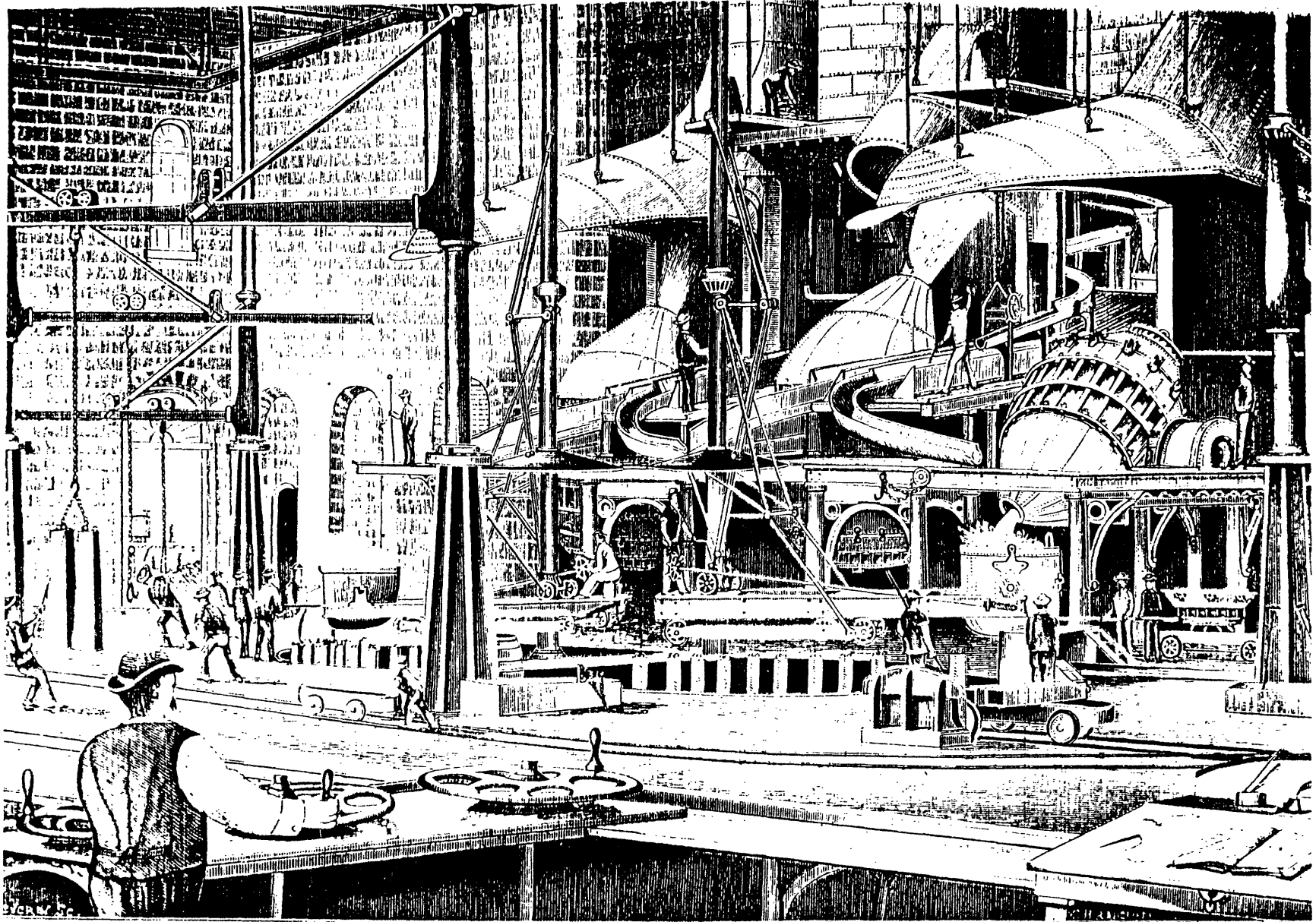

INTERIOR VIEW OF BESSEMER STEEL-MILL,  
PENNSYLVANIA STEEL-WORKS,  
STEELTON, PA.

Bessemer converters operating during the late nineteenth century at the Pennsylvania Steel Works at Steelton. The converters at left and center are blowing air through molten iron. The converter at right is pouring molten steel into a ladle. (Source: Box 2, Manuscript Group 214, Pennsylvania State archives.)

United States Department of the Interior  
National Park ServiceNational Register of Historic Places  
Continuation Sheet

Iron and Steel Resources of Pennsylvania, 1716-1945

E 49

Section number \_\_\_\_\_ Page \_\_\_\_\_

through the molten iron (shooting a brilliant stream of sparks and smoke out the top), the carbon was removed, and then the proper proportion of carbon was added to make steel. The Bessemer converter was then tilted over again to pour the molten steel into the ingot molds. Two converters were used since the Bessemer process was discontinuous, with two converters alternately starting and stopping cycles called heats, and because at first the heat-resistant brick lining in the bottom of the metal converter had to be replaced after one to three heats. Holley vastly improved the throughput, or the speed and quantity of materials that moved through the British process. He rearranged the converters to be side by side, and raised them off the ground, doing away with the pit and facilitating moving the ingots away once they were poured. He also invented a removable bottom for converters; a worn-out bottom could be removed and a new one put on without having to cool the furnace first, thus saving considerable down time for the converters. Other inventions helped improve the size, throughput and production costs of Bessemer converters during the 1880s and 1890s. For example, at the Cambria Iron and Steel Works, the Bessemer output for twelve months multiplied almost ten-fold from 24,934 tons in 1872-1873 to 237,530 tons in 1891-1892. By 1900 Pennsylvania had more and larger Bessemer converters--forty-two converters making 93,122 tons of steel on average that year--than any other state in the nation. The price of steel rails made in Pennsylvania principally with Bessemer converters fell from \$166.00 a ton in 1867 to \$32.29 in 1900.<sup>12</sup>

Production with Bessemer converters greatly affected other steps in iron and steel manufacture, including use of chemical analysis, larger scale production, and use of higher heat, especially in iron blast furnaces. Because the proportion of carbon as well as other elements was critical to the quality of Bessemer steel, chemists were hired to analyze the steel at various steps in the production process. Bessemer converters operated at higher temperatures than iron blast furnaces had, spurring improvements in refractory brick and other methods of containing high heat. These advances made it possible to use higher heat in other steps in iron and steel manufacturing, such as iron blast furnaces. The large output of Bessemer converters also required larger inputs and outputs from other stages of the steel making process. Most importantly, Bessemer works needed much more iron from blast furnaces than earlier iron rolling mills had required. Iron and steel mill managers therefore greatly increased the output of each blast furnace. As the output of each blast furnace grew, the ratio of the number of iron furnaces to the number of Bessemer converters declined by 1900 to about three or four to one. Thus although the number of iron furnaces in Pennsylvania declined during the 1880s and 1890s, their total output grew enormously.<sup>13</sup>

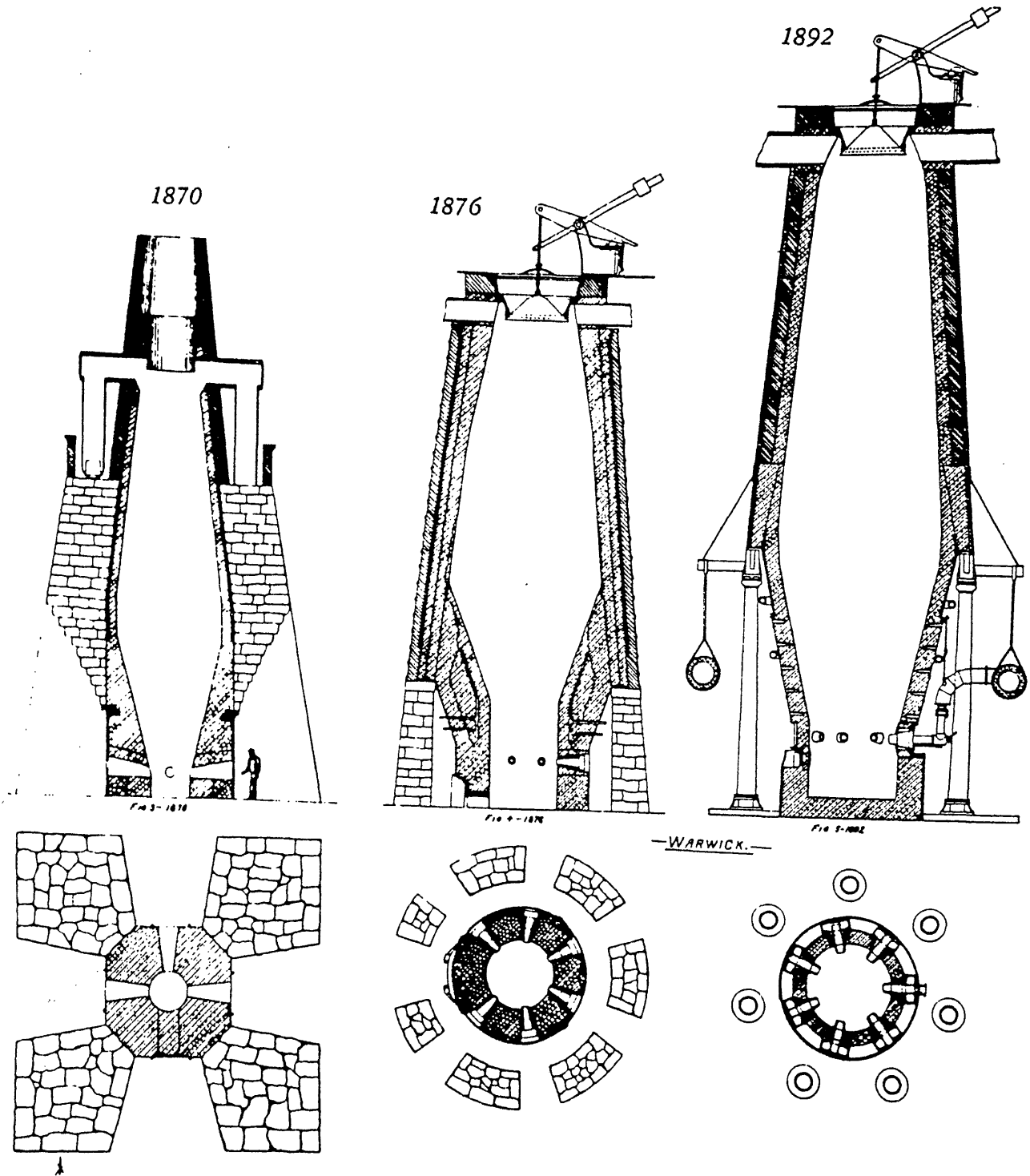

Typical iron blast furnaces from 1870 to 1892, showing their increasing size. (Source: David Weitzman, Traces of the Past: A Field Guide to Industrial Archaeology (New York: Charles Scribner's Sons, 1980), pp. 148-149.)

United States Department of the Interior  
National Park ServiceNational Register of Historic Places  
Continuation Sheet

Iron and Steel Resources of Pennsylvania, 1716-1945

E 51

Section number \_\_\_\_\_ Page \_\_\_\_\_

Engineers transformed the size, construction, and hot blast of iron furnaces in order to increase output. Most of the furnaces built after 1860 were cylindrical iron shells lined inside with refractory brick. This construction as well as other innovations enabled iron furnaces to grow from about seventy to seventy feet high and twenty feet wide in 1880 to approximately 100 feet high and twenty-two feet wide in 1900. Blast furnace managers also resorted to "hard driving," or increasing the output of a furnace over its rated capacity. They hard drove furnaces initially by using bigger and more blowing engines to blast more air under higher pressure into the furnace, thus raising the operating temperature and efficiency of the furnace. The beginning of hard driving furnaces dates to 1870 when the Lucy furnace was constructed in Allegheny County by Andrew Carnegie. The Lucy furnace made 13,000 tons of iron in 1872, about twice as much as the largest furnaces a decade earlier. In the 1880s inventors developed regenerative stoves in order to raise operating temperatures higher. The hot exhaust gases from the furnace were circulated around firebrick inside the stoves, heating the brick; the exhaust gases were shut off from the stoves; fresh air was circulated over the bricks and warmed; the preheated fresh air was then blasted into the furnace. Regenerative stoves helped to roughly double the temperature achieved by earlier hot blast methods.<sup>14</sup>

Advances in materials handling further improved the output of blast furnaces. Until the late nineteenth century wheelbarrows loaded with raw materials were hauled to the tops of furnaces and men dumped the wheelbarrow loads into the furnaces; such materials handling could neither keep up with the growing size of the furnaces, nor evenly distribute raw materials inside the furnace. A bell and hopper (later a double bell and hopper) were invented to open and admit raw materials into the top of the furnace and distribute them evenly inside. When closed, the bell diverted exhaust gases to regenerative stoves. Skip hoists that carried raw materials up the side of the furnace to the bell and hopper, and giant ore bridges that moved iron ore from ore pits to skip hoists also greatly facilitated the flow of materials into the furnace. When it was constructed in 1896, Blast Furnace No. 1 at the Duquesne steel mill, built by the Allegheny Bessemer Steel Company in 1889 and acquired by the Carnegie Company in 1890, was the first blast furnace in the nation to incorporate the skip hoist, ore bridge and other blast furnace innovations. Together these innovations increased the average annual output of the 148 iron furnaces in Pennsylvania to 45,801 tons in 1900. Blast furnaces in Pennsylvania were generally larger than the other 251 furnaces scattered elsewhere in the United States, which each produced an average 36,221 tons in 1900.<sup>15</sup>

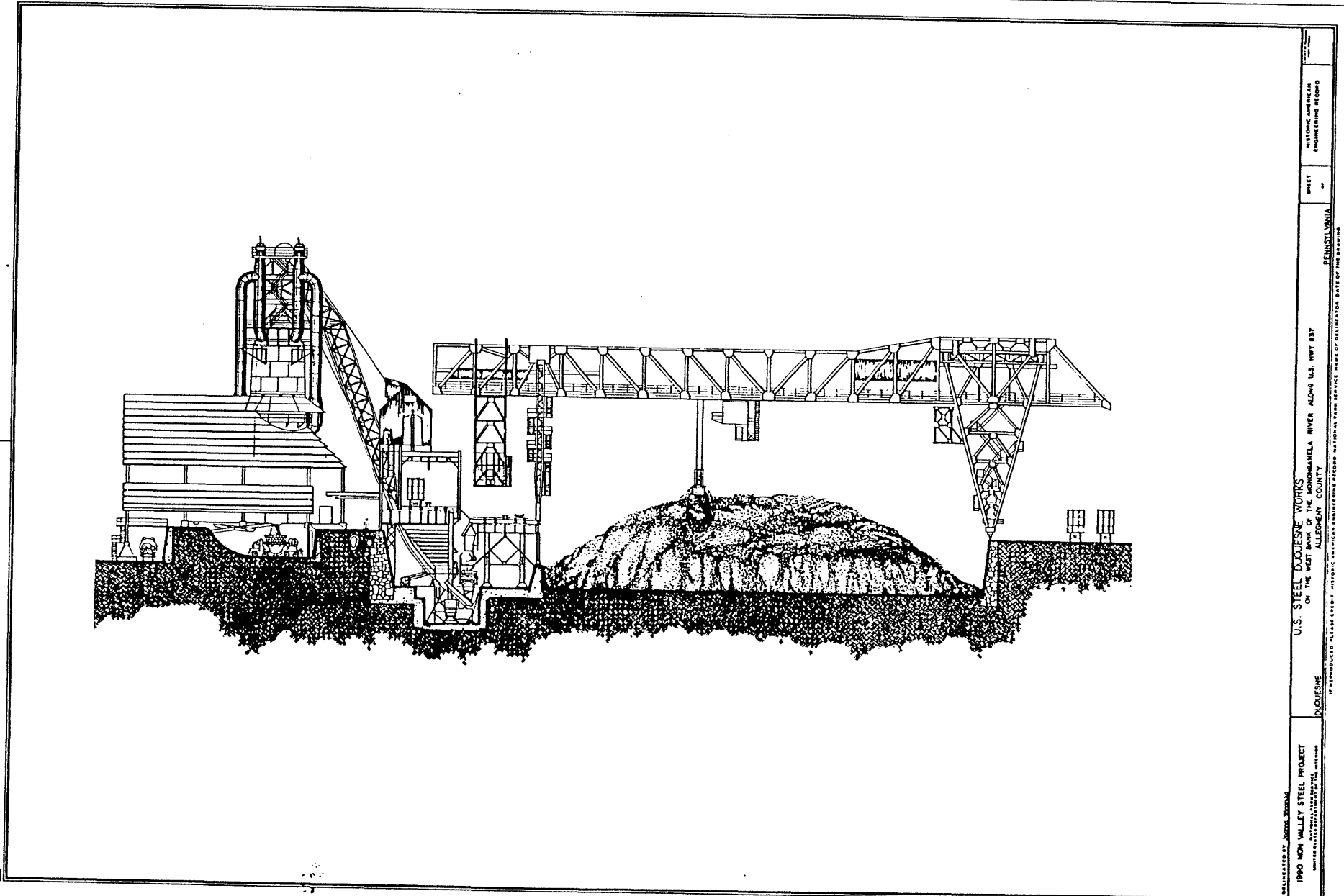

Duquesne Blast Furnace No. 1, as it appeared in 1990, with the ore bridge to the right, blast furnace to the left, and skip hoist and loading facilities in between. (Source: Historic American Engineering Record.)

1990 MON VALLEY STEEL PROJECT  
 U.S. STEEL DUCESNE WORKS  
 ON THE WEST BANK OF THE MONONGAHELA RIVER ALONG U.S. HWY 87  
 ALLEGANY COUNTY  
 PENNSYLVANIA  
 SHEET 2  
 NATIONAL ARCHITECTURAL ENGINEERING RECORD  
 REPRODUCED PLEASE CREDIT: HISTORIC AMERICAN ENGINEERING RECORD NATIONAL ARCHITECTURAL ENGINEERING RECORD

United States Department of the Interior  
National Park ServiceNational Register of Historic Places  
Continuation Sheet

Iron and Steel Resources of Pennsylvania, 1716-1945

E 53

Section number \_\_\_\_\_ Page \_\_\_\_\_

Hard driven iron furnaces and Bessemer converters produced steel used primarily in the manufacture of rails. Open hearth furnaces, first introduced in 1866, were used to make steel principally for other products. The open hearth furnace was essentially a puddling furnace in which hotter temperatures could be created. The iron was placed on a hearth and exposed to burning gases. Unlike a puddling furnace, however, the gases were heated first in a regenerative stove similar to the regenerative process used in blast furnaces. The regenerative stove helped raise the temperature inside the furnace above the melting point of wrought iron, eliminating the need for a puddler to stir the iron.

Despite their simplicity of operation, open hearth furnaces were only slowly adopted. Open hearths had a considerably smaller capacity than Bessemer converters, and took much longer to transform iron into steel--six hours or more compared to about twenty minutes for Bessemer converters. These factors made them more expensive to operate than Bessemer converters. On the other hand, open hearth furnaces gained the advantage of removing phosphorous, which greatly harmed the quality of steel, from the molten iron. A basic lining was installed on the interior of the open hearth furnace in order to remove phosphorous. The basic lining combined with the phosphorous, and this combination was poured out of the furnace as part of waste molten slag. This advance enabled steel makers to use a much wider range of iron ores containing varying proportions of phosphorous than Bessemer converters could utilize. Bessemer converters usually had acid linings that did not combine with phosphorous, restricting the types of iron ore used to a much smaller range of more expensive ores. By 1900 open hearth furnaces using less expensive iron ores lowered the costs of open hearth steel to roughly those of Bessemer steel. The basic lining therefore made open hearth furnaces attractive to steel producers who were ever mindful of costs.<sup>16</sup>

Open hearth furnaces had other advantages that led to their increasing adoption. They could use more scrap iron than Bessemer converters did, at a time when the quantity of scrap iron was increasing and its price was gradually decreasing. In addition, steel producers and customers ascribed better reliability, uniformity, and strength (especially under stress) to open hearth steel than to Bessemer steel. Thus manufacturers and customers often preferred open hearth steel to Bessemer steel for products, such as structural shapes, in which strength, reliability and uniformity were critical. Because demand for such products was growing faster than for Bessemer steel rails near the end of the century, capitalists switched increasingly to making open hearth steel in Pennsylvania, and to a lesser extent in other states. By 1900 open hearth furnaces produced almost four tenths of the steel made

**United States Department of the Interior  
National Park Service****National Register of Historic Places  
Continuation Sheet**

Iron and Steel Resources of Pennsylvania, 1716-1945

E 54

Section number \_\_\_\_\_ Page \_\_\_\_\_

in Pennsylvania. The forty-two Bessemer converters in the Commonwealth manufactured a total of 3,911,127 tons of steel in 1900, while 404 open hearth furnaces manufactured 2,437,918 tons. Nationwide Bessemer converters made 7,532,028 tons while 638 open hearth furnaces manufactured 3,044,356 tons.<sup>17</sup>

Major advances in rolling machinery, including the development of continuous rolling, greatly increased the throughput of rolled iron and steel and cut production costs, particularly labor costs. The three high mill was rapidly adopted by the 1870s in Pennsylvania mills, speeding the movement of material back and forth through rolling stands. As larger ingots were cast from iron and steel furnaces, larger rolling stands were developed to squeeze and stretch out the ingots into various shapes. In 1866 George Fritz created at the Cambria Iron Works a blooming mill for reducing a large ingot to a smaller width that could be handled by smaller roll stands. In 1871 Alexander Holley developed a three high blooming mill in which the center roll could be moved up and down, enabling rolling mills to roll ingots of various sizes. British inventors created a reversing two high roll stand through which still larger ingots could pass back and forth. Two high reversing rolls were first installed at the Shoenberger Works in Pittsburgh in 1877, and subsequently spread throughout the industry. In 1867 the universal plate mill was developed to simultaneously roll the top, bottom and side edges of iron and steel plate, an advance over previous mills that rolled the top and bottom or the sides separately. All these advances made it possible to roll larger pieces of material more quickly into a greater variety of shapes. By the 1880s the development of lifting tables and rollers that linked rolling stands also greatly facilitated throughput and slashed the number of workers needed to handle iron and steel in rolling mills. Lifting tables on either side of rolling stands raised and lowered heavy pieces of iron or steel into position for passage back and forth through rolls. Long series of rollers located between roll stands passed material from one roll stand to the other. Two, three or more roll stands were thus linked by rollers into roll trains that continuously squeezed and stretched out iron and steel into various shapes. These roll trains grew up to hundreds of feet long as ingots moved in one end of the rolling mill and finished shapes came out the other end.<sup>18</sup>

Manufacturers had to overcome bottlenecks between the various stages of production--the iron blast furnaces, steel furnaces, and rolling mills--as the output of each stage increased. They linked and integrated these stages into one gigantic plant, further increasing throughput and decreasing costs. Blast furnaces were linked directly to Bessemer converters by gigantic buckets or ladles carrying molten iron

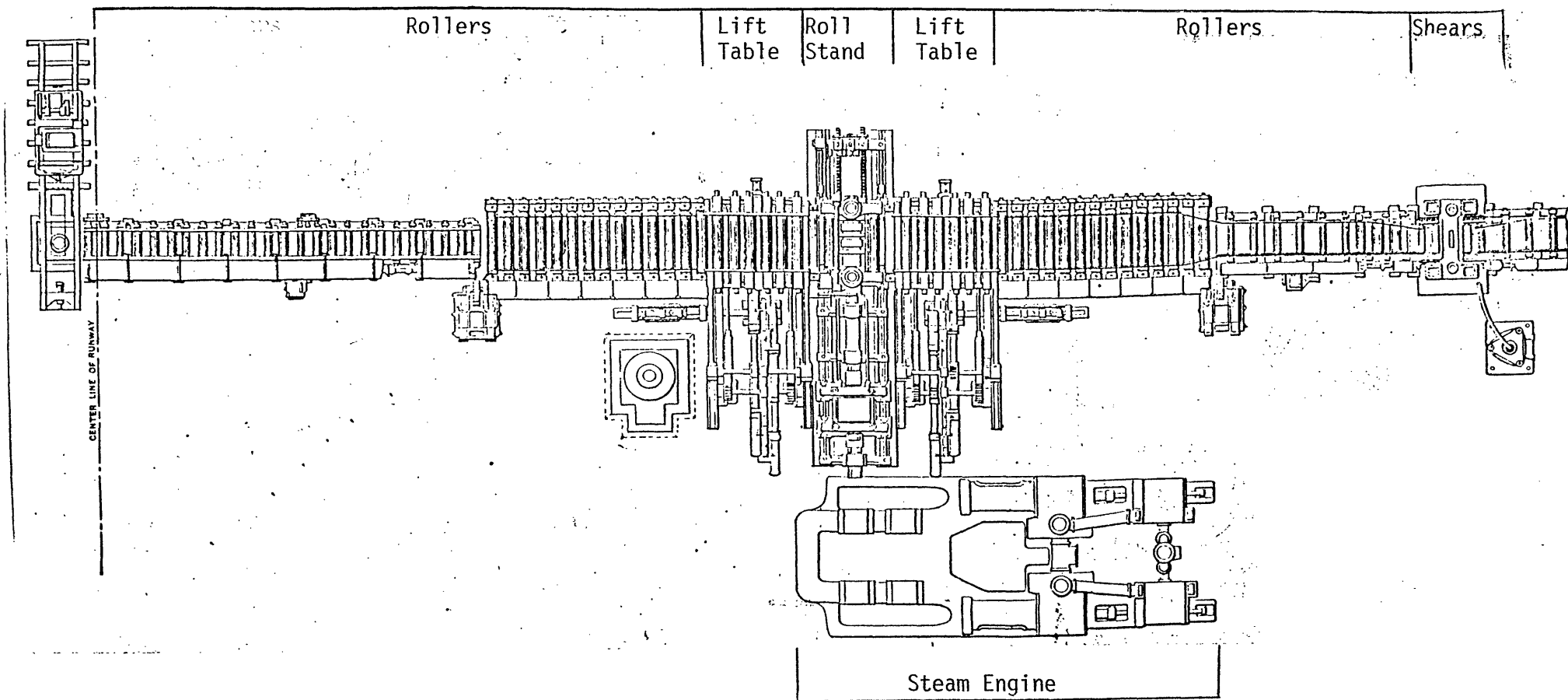

A roll train installed at Bethlehem Steel Company's Bethlehem plant in 1907. This roll train, including rollers, lift tables, roll stand, steam engine that powered the roll stand and tables, and shears that cut the rolled steel, was used to roll ingots. The roll train was approximately two hundred feet long. (Source: "The Grey Structural Mill at South Bethlehem," The Iron Age, January 2, 1908.)



**United States Department of the Interior  
National Park Service****National Register of Historic Places  
Continuation Sheet**

Iron and Steel Resources of Pennsylvania, 1716-1945

E 56

Section number \_\_\_\_\_ Page \_\_\_\_\_

to the converters. This practice, which began at Bethlehem and Chicago and quickly spread to other mills, eliminated the need to cast iron ingots at the blast furnaces and then reheat them in cupola furnaces at the Bessemer works. The Jones mixer, developed by Captain William Jones at the Edgar Thomson plant, perfected this linkage by holding large quantities of molten iron from several blast furnaces. The Jones mixer made the quality of iron loaded into steel furnaces more consistent by mixing iron of varying qualities from several furnaces into one molten mass. Integration between steel furnaces and rolling mills was improved at the Duquesne Works where steel ingots were cast directly on railroad flat cars which moved the ingots to the rolling mills. This innovation ended the step of casting steel ingots on the shop floor, then hoisting them onto cars for delivery to the rolling mills. When Andrew Carnegie bought the Duquesne plant, he introduced this casting method into his other plants, and the practice quickly spread to other firms.

Integration of production stages helped lead to much larger plants than had ever existed before. Production facilities that covered a few acres before the Civil War expanded to encompass scores of acres. Iron blast furnaces, steel furnaces, rolling mills and ancillary buildings were usually located next to each other on the same site. Generally steel plants were built on the flood plains next to rivers and rail lines. The flood plain provided flat, open land for the plants, a river offered the large quantities of water needed to cool machinery and product at various steps in the process, and rail lines were essential to transporting large quantities of raw materials and finished products in and out of the plants. Steel plants grew so large that manufacturers ran out of room on the flood plain in and nearby Pittsburgh, where steel mills in the Pittsburgh area were first concentrated. By 1900 they were constructing steel mills farther up the Monongahela River and down the Ohio River from Pittsburgh.

The transformation of the Pennsylvania Steel Company's plant at Steelton in just three decades illustrates the rapid metamorphosis in the size and appearance of steel plants in Pennsylvania. The firm began this plant in 1867 with two Bessemer converters in a Bessemer building. In 1868 a rail mill was opened close by. By 1875 the company had constructed two blast furnaces with a cast house extending from the base of each furnace. These two furnaces were linked by a shared stock house and flanked by an engine building which provided the blast for the furnaces. By 1875 the firm also built a second Bessemer shop, and a forge mill apparently used to reduce steel ingots before they went to the rail mill. An iron foundry, machine shop, and a shop for making railroad frogs (a device on intersecting rails that permits wheels to cross the junction) also stood nearby. By 1896 the Pennsylvania Steel

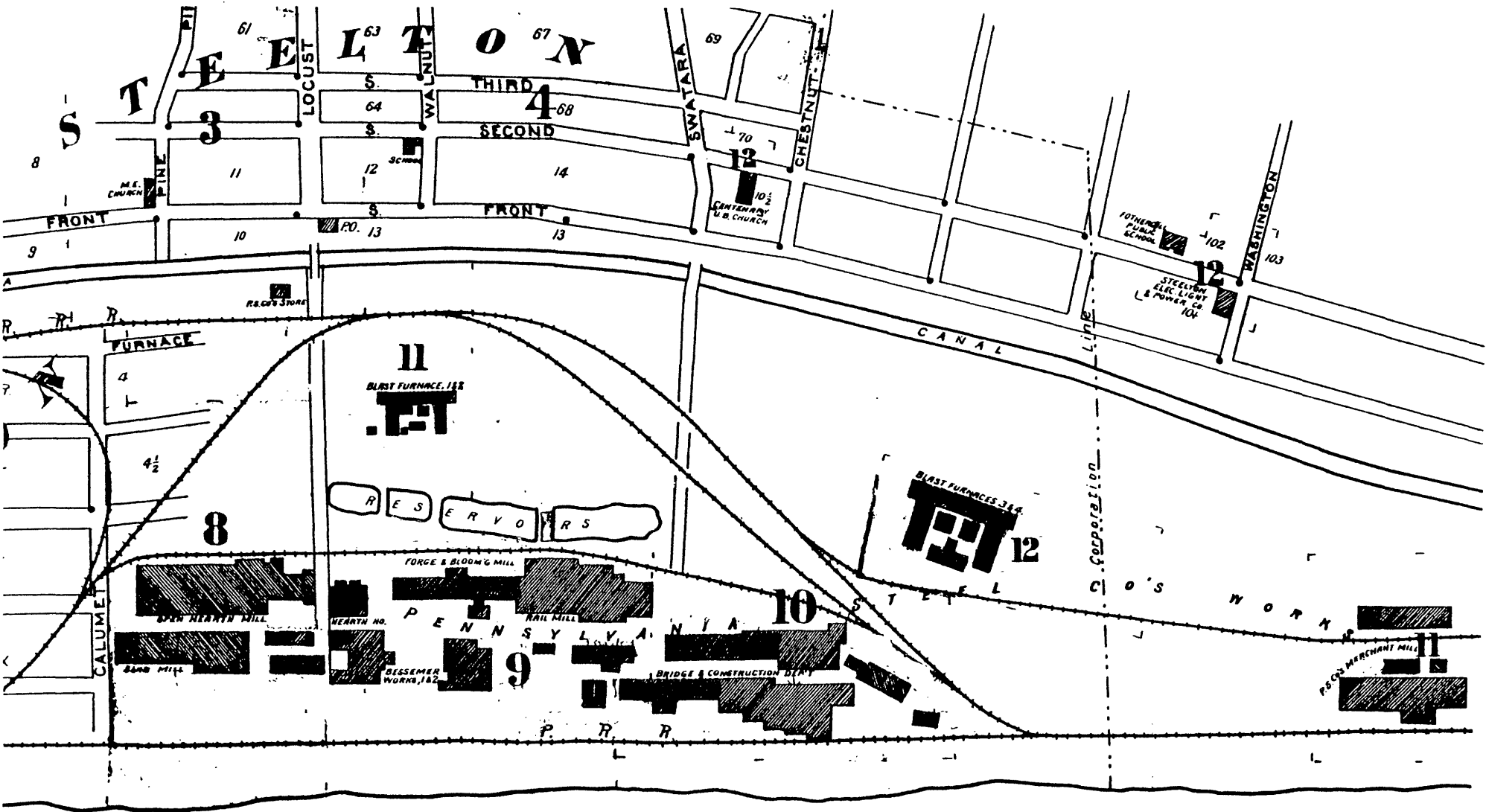

Diagram of the Pennsylvania Steel Company's plant at Steelton in 1896, showing foot prints of steel plant buildings, and the streets of adjacent Steelton. (Source: Sanborn Map Company, 1896.)

**United States Department of the Interior  
National Park Service****National Register of Historic Places  
Continuation Sheet**

Iron and Steel Resources of Pennsylvania, 1716-1945

E 59

Section number \_\_\_\_\_ Page \_\_\_\_\_

Company greatly expanded these facilities. Five blast furnaces--two sets of paired furnaces and a single merchant furnace--provided iron for the plant's steel furnaces, or for sale outside the plant. A large open hearth furnace building augmented the two Bessemer shops. The forge mill had been expanded to include a blooming mill, both of which were connected directly to the rail mill. The firm also added a slab mill, apparently used to roll slabs of steel for sale outside the plant. The company had also expanded its product line with a bridge and construction building in which structural components of bridges and buildings were fitted before shipment to the final erection site. The original plant, which had been confined to approximately eighteen acres, had grown to cover about eighty acres, next to the Pennsylvania Railroad Main Line and the Susquehanna River.<sup>21</sup>

Transformations in fuel and iron sources also led to the rise of giant iron and steel plants in Pennsylvania, and the gradual demise of earlier, smaller iron furnaces. Charcoal furnaces were a virtual relic by 1900. Only eight small charcoal furnaces having less than one per cent of the state's total iron furnace capacity remained operating in 1900. These few furnaces subsisted at the margins of the industry by making very specialized products, such as railroad car wheels, which required the particular qualities in iron that charcoal furnaces could produce best. For the vast majority of products, however, blast furnaces fired by other fuels provided iron at lower cost. Charcoal furnaces disappeared because they could not achieve the economies of scale that other types of furnaces did; charcoal was not physically strong enough to support heavy burdens of ore inside large furnaces, greatly limiting the size and output of charcoal furnaces. Charcoal furnaces were also less efficient since they could not utilize the higher operating temperatures being achieved in other types of iron furnaces. In addition, charcoal furnaces had often depleted vast areas of nearby timberland, increasing their fuel costs. As charcoal furnaces went out of blast, areas of the state that had been prominent in the charcoal iron industry, such as the Juniata iron region and southeastern Pennsylvania, declined in importance in the iron industry.<sup>22</sup>

Changing fuel sources also greatly affected the success of anthracite furnaces in Pennsylvania. Iron furnaces, especially in eastern Pennsylvania, increasingly used anthracite coal until about 1880, but then anthracite began a rapid decline in favor of coke produced from bituminous coal. Western Pennsylvania furnaces, which were nearby bituminous coal beds used to make coke, shifted sooner to coke than eastern blast furnaces did. Eastern furnaces, which were closer to anthracite fields, clung to anthracite as a fuel longer, often mixing coke with anthracite for fuel during the 1880s and 1890s. However, even

United States Department of the Interior  
National Park ServiceNational Register of Historic Places  
Continuation Sheet

Iron and Steel Resources of Pennsylvania, 1716-1945

E

60

Section number \_\_\_\_\_ Page \_\_\_\_\_

in eastern Pennsylvania coke became the clearly dominant fuel by 1900. Between 1880 and 1900 the number of furnaces in Pennsylvania using anthracite or an anthracite/coke mixture fell from 158 to seventy furnaces which had only twenty-eight per cent of the state's total iron making capacity. On the other hand, seventy coke furnaces accounted for seventy-one per cent of the Commonwealth's iron capacity in 1900.<sup>23</sup>

Coke superceded anthracite because it became more cost effective to fire furnaces with coke. Even in eastern furnaces near anthracite mines, iron and steel mills found it cheaper by 1900 to transport coke across the state and use it rather than utilize anthracite. Coke could produce higher and more efficient operating temperatures in blast furnaces since coke is more porous than anthracite, allowing more air to be blown through the coke for hotter combustion. Anthracite furnaces also were smaller; in 1900 the average Pennsylvania coke furnace had two and one half times the capacity of the average anthracite- or anthracite/coke-fired furnace. In addition, anthracite furnaces could not be rebuilt to use solely coke as fuel. When larger proportions of coke were used in an anthracite furnace, the design of the furnace forced ironmasters to decrease the force of the blast, reducing the output of the furnace.<sup>24</sup>

The growing reliance on coke fostered the enormous expansion of the coke industry in Southwestern Pennsylvania during the 1870s to 1890s. Coke was made in beehive ovens that heated bituminous coal and burned off liquid and gaseous hydrocarbons, leaving the carbon material or coke behind. Beehive coke ovens were concentrated, often in long lines next to rail spurs, in the Connellsville Coke Region, which had the best coking coal available in the Northern United States. Beehive ovens were built on top of the coking coal beds since the ovens reduced considerably the weight of coal as it was transformed into coke, making it cheaper to transport coke than coal. Various railroad companies, especially the Pennsylvania Railroad, stretched rail lines into the Connellsville Coke Region in order to carry millions of tons of coke to industrial plants in the Northeastern United States, particularly iron and steel mills. With improved transportation and growing demand, the state's coke industry grew rapidly from about 300 beehive ovens in 1870 to 26,801 in 1899. By 1899 Pennsylvania produced 13,245,594 tons of coke or just over two thirds of all the coke made in the country. The Henry C. Frick Company, established and run by Henry C. Frick, dominated the coke industry during the 1880s and 1890s.<sup>25</sup>

Changing sources of iron ore also affected the success of iron and steel plants in Pennsylvania. The Commonwealth mined more iron ore up to 1880 than any other state. However, the Commonwealth's ore deposits were

United States Department of the Interior  
National Park ServiceNational Register of Historic Places  
Continuation Sheet

Iron and Steel Resources of Pennsylvania, 1716-1945

E 61

Section number \_\_\_\_\_ Page \_\_\_\_\_

too small to satisfy the growing appetite for ore in the Pennsylvania iron and steel industry, with many of the state's ore deposits being depleted by 1880. Much of the ore mined in Pennsylvania also contained too much phosphorous to be utilized in Bessemer converters. Local Pennsylvania ores gave way to Lake Superior and imported ores from the 1870s through 1901. Iron ore had been discovered in the remote upper peninsula of Michigan in 1844. Construction of the Sault St. Marie Canal connecting Lake Superior and Lake Huron, large steam-powered ore boats, and better loading and unloading facilities made it possible to transport large quantities of this ore to iron and steel mills by the 1870s. The discovery of more, huge ore deposits such as the Menominee Range led to the rapid development of iron mining in Michigan during the 1870s and 1880s. By 1890 Michigan mined almost four times as much ore as Pennsylvania. The discovery of other huge deposits farther west in Wisconsin and Minnesota, especially the vast Mesabi Range found in Minnesota in 1890, opened still more ore deposits to iron and steel plants in the northeastern United States. By 1900 Minnesota and Michigan were each producing more than eleven times the amount of ore that declining Pennsylvania mines produced. Much of the Lake Superior ores were high-grade, and ore in the Mesabi Range had the added advantage of being<sup>26</sup> located in large beds near the surface where it was easier to mine.

Imported ore became an important source of raw materials for several major eastern Pennsylvania mills. By 1885 a growing proportion of ore used in America's iron and steel plants was imported, principally from Cuba, but also from Spain and Algeria. Although not more than ten per cent of the ore used in the United States came from abroad, much of the Cuban ore was used by the Pennsylvania Steel Company at its Steelton plant, and at its new facility opened in 1887 at Sparrows Point, Maryland. The two plants had higher transportation costs for Lake Superior ores, since they were farther away from these deposits than most other northeastern United States plants. But they had much lower transportation costs for foreign<sup>27</sup> ores because they were located on or fairly near the Atlantic coast.

These changing sources of fuel and iron ore were a critical factor in keeping America's iron and steel industry concentrated in Pennsylvania, and making western Pennsylvania, especially the Pittsburgh area, the iron and steel capital of the United States. From 1870 to 1900, Pennsylvania manufactured approximately one half of the country's iron and steel, or almost three to four times more than the next most productive state, Ohio. Within the Commonwealth Allegheny County was by far the center of iron and steel production. Between 1880 and 1900 this county manufactured three to nine times more iron and steel than the

**United States Department of the Interior  
National Park Service**

**National Register of Historic Places  
Continuation Sheet**

Iron and Steel Resources of Pennsylvania, 1716-1945

E 62

Section number \_\_\_\_\_ Page \_\_\_\_\_

next most productive county in the state. In fact, with plants such as the gigantic Edgar Thomson Works, Allegheny County made more iron and steel than any other county in the nation during this period. Three of the four next most important counties in Pennsylvania in terms of total output in 1900--Cambria, Mercer and Lawrence--were also located in the western half of the state. Cambria County contained the large Cambria Iron and Steel Company, while Mercer and Lawrence Counties included furnaces supplying iron to Pittsburgh-area mills. Leading eastern Pennsylvania counties in 1900 were Dauphin County, with the Pennsylvania Steel Company's Steelton plant, Lackawanna County with the Lackawanna Iron and Steel Works, Montgomery County, and Lehigh County with the Bethlehem Iron Company.

Tonnages of iron and steel manufactured by leading counties in Pennsylvania, 1880-1900

County	Year		
	1900	1890	1880
Allegheny	8,203,715	3,389,329	757,273
Cambria	927,676	509,223	232,268
Mercer	841,800	440,198	163,287
Dauphin	760,864	512,369	199,711
Lawrence	699,414	234,210	78,967
Lackawanna	572,030	491,189	135,065
Montgomery	480,948	304,352	150,561
Lehigh	385,109	367,131	290,067
State Total	15,290,711	8,622,745	3,229,168 <sup>29</sup>

America's iron and steel industry concentrated in Pennsylvania, particularly western Pennsylvania, in large part because of lower materials assembly costs. With the growing reliance on coke, Pennsylvania's western iron and steel plants were strategically located near the Connellsville Coke Region. They had the lowest costs of any mills in the northern United States for assembling or transporting coke to their plants. Some western Pennsylvania iron and steel firms, especially the Carnegie Company, gained control of various areas of the Connellsville Coke Region coal beds in order to ensure a long-term supply of coke. In 1882 the Carnegie Company bought its way into the Henry C. Frick Company, eventually becoming the main shareholder and making Frick a leading partner in the Carnegie Company. Western Pennsylvania plants also had relatively low costs for transporting Lake Superior iron ore. Although Lake Superior ore was located hundreds of miles from western Pennsylvania plants, ore was carried most of the

United States Department of the Interior  
National Park ServiceNational Register of Historic Places  
Continuation Sheet

Iron and Steel Resources of Pennsylvania, 1716-1945

E 63

Section number \_\_\_\_\_ Page \_\_\_\_\_

distance in Great Lakes ships, which were the cheapest form of transporting ore. Lake Superior ore was then hauled from Lake Erie ports such as Erie to Pennsylvania plants by railroad. Western Pennsylvania companies had shorter and therefore less expensive rail hauls than eastern plants did. The Carnegie Company increased its competitive advantage in rail transportation in the 1890s by developing its own rail line from Lake Erie to its Pittsburgh mills, the Pittsburgh, Bessemer and Lake Erie Railroad. Western Pennsylvania iron and steel firms, and again especially the Carnegie Company, also tried to secure long-term access to various Lake Superior ore beds. By 1897 Andrew Carnegie reached a fifty-year agreement with John D. Rockefeller, who owned large tracts of Lake Superior beds, to purchase large amounts of iron ore. Through his coke, railroad and iron ore dealings, Carnegie secured long-term supplies of critical raw materials at cheap and fairly stable prices.

Eastern Pennsylvania mills compensated for higher materials assembly costs by being located nearer to northeastern United States markets than western mills, specializing in products targeted at these markets, and importing foreign ore. The Bethlehem Iron Company, for instance, concentrated on producing armor plate bought by ship manufacturers in northeastern ports. The Pennsylvania Steel Company was located on the Main Line of the Pennsylvania Railroad Company, to which it sold its rails. This firm diversified into bridge and construction assembly by the turn of the century in order to supply northeastern cities and transportation projects. By supplying the northeast, eastern plants lowered their transportation costs of finished goods; western mills could not transport as cheaply the same products over longer distances to the rapidly growing northeast. Importing foreign iron ore also helped overcome the lower materials assembly costs of western Pennsylvania mills. In addition to the Pennsylvania Steel Company, the Bethlehem Iron Company also imported ore during the late nineteenth century.

While eastern and western Pennsylvania plants competed with each other, the Commonwealth's mills as a group faced growing competition from Ohio and Illinois iron and steel mills. Between 1870 and 1900 these two states increased their proportion of national iron and steel production from thirteen per cent to twenty eight per cent. By 1900 Ohio and Illinois ranked second and third respectively in terms of tons of iron and steel manufactured. Production in Illinois centered by 1900 in Chicago and surrounding Cook County, Illinois, where most of the gigantic plants owned by the Illinois Steel Corporation (formed in 1889 by the merger of the North Chicago Rolling Mill Company, the Joliet Steel Works, and the Union Steel Company) were located. In Ohio Mahoning

**United States Department of the Interior  
National Park Service****National Register of Historic Places  
Continuation Sheet**

Iron and Steel Resources of Pennsylvania, 1716-1945

E 64

Section number \_\_\_\_\_ Page \_\_\_\_\_

County which contains Youngstown and Cuyahoga County which contains Cleveland were the centers of production, including mills operated by the Ohio Steel Company in Mahoning County that produced iron and steel billets, slabs and sheet. Cook County mills had the advantage over Pennsylvania plants of being located on Lake Michigan, eliminating long railroad hauls from Great Lakes ships to production sites. Cook County plants also included large rail mills, which were located closer than Pennsylvania mills were to western United States railroads. These railroads were purchasing more rails for new track than railroads in the Northeast were by 1900. Mills in Cuyahoga County were favored by their location near the Great Lakes port of Cleveland. Mahoning County plants had the disadvantage of fairly long shipping distances for both iron ore and coke; yet they also were near Pittsburgh-area rolling mills, which they supplied with iron and steel billets and slabs.<sup>32</sup>

Growing competition from Ohio and Illinois provided further impetus for Pennsylvania mills to find still more ways, in addition to technological advances, large-scale production, materials assembly advantages, and market proximity, by which they could cut costs. Pennsylvania firms, and particularly the Carnegie Company, adopted new management techniques in order to run the increasingly larger mills more efficiently. Central coordination of the various stages of production in a gigantic iron and steel mill was difficult. Each part of the process involved different activities, and various sections of the plant were managed by powerful foremen who directed the day-to-day production in their section, and hired, fired and promoted workers. Andrew Carnegie and his company developed the most effective structure for central coordination of foremen and the various stages of production. Carnegie had worked for the Pennsylvania Railroad before moving to iron and steel, and he and his general manager, William P. Shinn, transferred from the railroad the voucher system of cost accounting. In this system each department listed the amount and cost of materials and labor used to make products as they passed through the department. Using the voucher system, Carnegie could eventually track the daily costs of materials and labor through his mills, enabling him to learn about and control even minute costs throughout the production process. He could also evaluate attempts to reduce costs, such as technological innovations, and he could charge the lowest possible prices on finished goods since he knew his costs quite accurately. In addition to hiring a general manager and a general superintendent to coordinate the day-to-day operations at a mill, Carnegie also employed accountants who provided statistical control of the plant, and engineers who oversaw equipment maintenance.<sup>33</sup>



**United States Department of the Interior  
National Park Service****National Register of Historic Places  
Continuation Sheet**

Iron and Steel Resources of Pennsylvania, 1716-1945

Section number     E     Page     65    

Improved management of mills also included better design of plant layouts in order to facilitate movement of materials and products through the plant, thus increasing throughput and cutting costs. Most iron and steel plants built through the 1870s were erected with little thought given to the efficient flow of materials. For example, many of the Bessemer plants established in Pennsylvania during the late 1860s and 1870s had Bessemer converters that were not placed with close access to both iron blast furnaces and rolling mills. Alexander Holley was the first engineer who recognized the need to design mills with layouts that speeded materials flow through the plant. He developed features of plant design that were incorporated into other large iron and steel mills by the late nineteenth century, including fitting the production buildings to rail lines. Holley had buildings erected parallel to railroad spurs with easy curves so that materials and products could be quickly loaded and unloaded from railroad cars, and the cars could be moved quickly through the plant. Buildings housing inter-related stages in the production process were also placed near each other, and were connected directly by rail lines to speed materials transfer from one stage to the next.

The Edgar Thomson Works, which Holley designed as a completely new plant, was the first mill to implement his design features. In other ways as well--cost accounting methods, technological improvements, and production efficiency--the Edgar Thomson Works epitomized advances in the nation's iron and steel industry during the late nineteenth century. Holley's 1875 plant incorporated spurs from three railroad lines that delivered coke and pig iron directly to stockyards, and other spurs that paralleled the rail mill and moved rails out of the plant. A network of narrow gauge railways within the plant connected the Bessemer converter shop with rolling mills and other buildings. The Lucy Furnace and another hard driven furnace, the Isabella Furnace, both of which were located nearby, provided pig iron for the plant through the 1870s. When the Carnegie Company began erecting even larger hard-driven iron furnaces at the Edgar Thomson Works, it placed the furnaces between parallel railroad spurs, again facilitating materials handling. It also paired furnaces around regenerative stoves, an engine house and boiler house, so that the two furnaces could share the stoves, engine house and boiler house. The iron furnaces were connected to the Bessemer shop by a direct track with easy curves. With Carnegie's penchant for adopting new technology and cutting costs, numerous technological innovations were either developed here, as was the Jones mixer, or were quickly adopted by the Carnegie Company, as continuous rolling was. Carnegie and Shinn also instituted their voucher system of accounting first at this plant. These design, technological and management innovations, together with Carnegie's resolute policy of plowing profits back into the plant, made

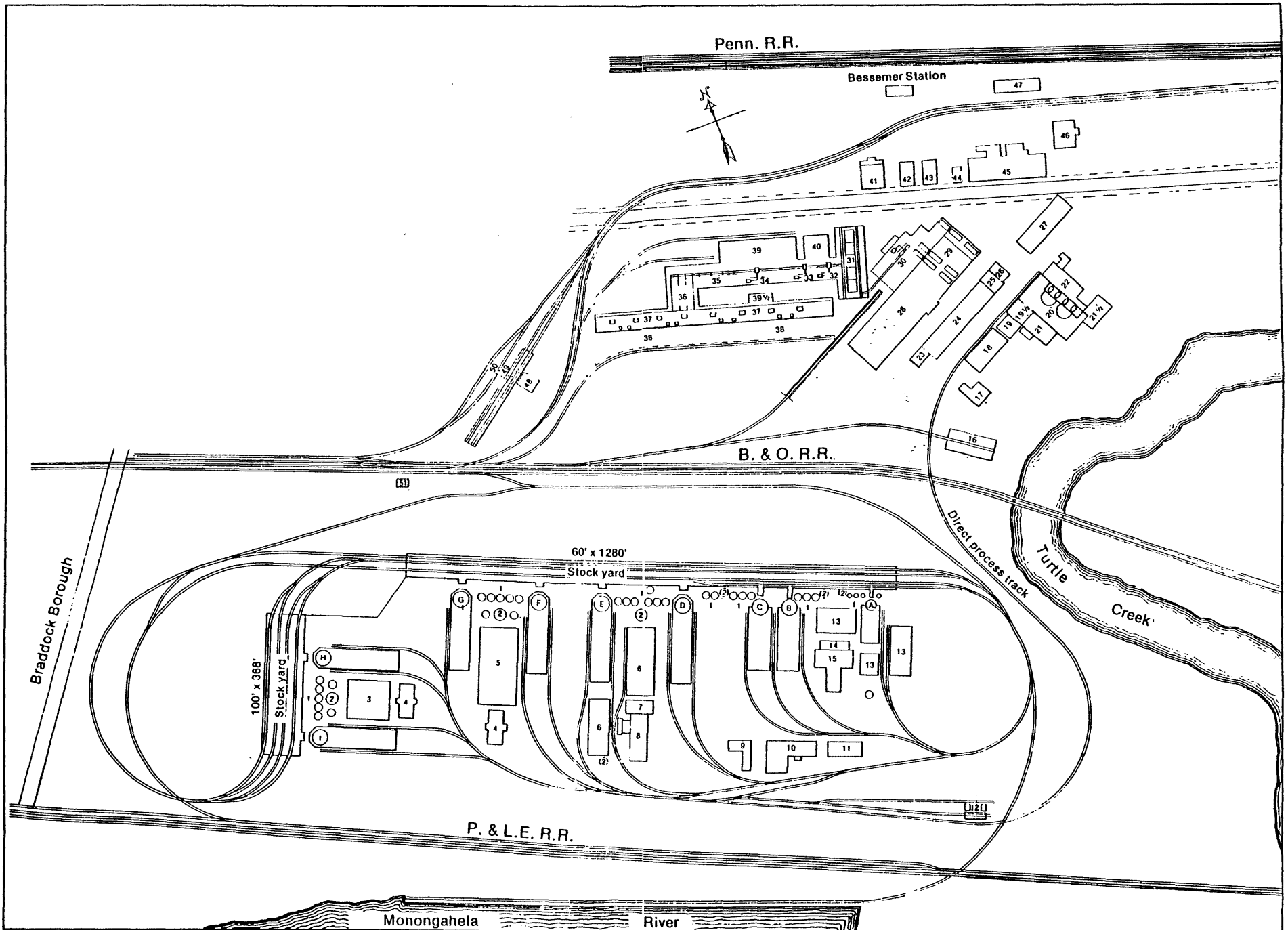

Plan of the Edgar Thomson Works, c. 1885. See the following page for a key to the structures. (Source: Alfred D. Chandler, *The Visible Hand: The Managerial Revolution in American Business* (Cambridge: Harvard University Press, 1977), pp. 263-265.

1	Stoves	25	Pump house
2	Stacks	26	Baker blowers
H and I	Blast furnaces, Cast houses	27	Boiler house
	Boiler house	28	Old rail mill
3	Boiler house	29	Ingot furnaces
4	Engine houses	30	Blooming mill
F and G	Blast furnaces, Cast houses	31-38	New rail mill
5,	Boiler house	31	Bloom furnaces
D and E	Blast furnaces, Cast houses	32	First roughing train
6	Boiler houses	33	Second roughing train
7	Pump house and tank	34	Finishing train
8	Engine house	35	Hot saws
A	Blast furnace, Cast house	36	Hot beds
B and C	Blast furnaces, Cast houses	37	Straightening and drill presses
13	Boiler houses	38	Loading beds
14	Pump house	39	Boiler house
15	Engine house, Engine house wing	39½	Pump house
12	Metal mixer	40	Roll shop
9	Offices and laboratory	41	Forge
10	Shops	42	Warehouse
11	Warehouse	43	Warehouse
16	Locomotive house	44	Office
18-22	Converting dept.	45	Machine, carpenter, and pattern shops
18	Boiler house	46	General offices, laboratory, drawing room
19	Blowing engines	47	Manganese shed
19½	and pumps	48	Boiler house
20	Converting house	49	Limestone crusher
21	Ladle house	50	Elevator
21½	Bottom house	51	Switch tower
22	Cupolas		
23	Electric light house		
24	Boiler house		

**United States Department of the Interior  
National Park Service****National Register of Historic Places  
Continuation Sheet**

Iron and Steel Resources of Pennsylvania, 1716-1945

E 68

Section number \_\_\_\_\_ Page \_\_\_\_\_

it one of the most profitable iron and steel facilities in America. In 1878, after only three years of production, the Edgar Thomson Works made a profit of \$401,000 or a thirty-one per cent return on equity. The profit soared to \$2,000,000 in the next two years.<sup>35</sup>

The Carnegie Company led another important trend in the Pennsylvania and United States iron and steel industry--the collusion and consolidation of firms, culminating by 1901 in oligopolies. Pennsylvania and other American iron and steel producers at first colluded by forming pools in order to control competition and ensure sales, stable prices, and profits for their companies. In 1875 Bessemer steel rail manufacturers first tried to form a pool, or an agreement to share the market according to preset quotas, but failed. Subsequent pools among steel rail producers tried to set production quotas or stabilize prices, with rail pools being most effective at stabilizing prices between 1890 and 1897. Attempts to form pools in other sectors of the iron and steel industry, such as among manufacturers of structural shapes, usually failed. Agreements on prices and production quotas frequently could not be enforced among members of a pool.<sup>36</sup>

The failure of pools and efforts at vertical and horizontal integration led to the consolidation of iron and steel companies and the creation of oligopolies, particularly from 1898 to 1901. Large firms such as the Carnegie Company vertically integrated backwards from manufacturing iron and steel into mining and transporting raw materials, including investing in Lake Superior iron mining companies, and in bituminous coal mining and coking firms during the 1880s and 1890s. In addition to securing long-term supplies of raw materials at fairly stable prices, they wanted to share in the profits that large mining and coking companies such as the Henry C. Frick Company were making. Iron and steel firms seldom integrated forward into metal fabrication companies that used their products. Pennsylvania and other American iron and steel companies also integrated horizontally, buying plants that manufactured the same product and thereby eliminating competition. Carnegie acquired the Bessemer rail mill erected by the Pittsburgh Steel Company and the Duquesne steel rail mill built by the Allegheny Bessemer Steel Company in order to end competition with his Edgar Thomson Works. These efforts to consolidate plants and firms peaked between 1898 and 1901, with producers in a number of sectors forming huge, often monopolistic companies. In March, 1898 seven wire and nail firms that together manufactured seventy-five per cent of the nation's total wire products joined to form the American Steel and Wire Company of Illinois. In January, 1899 the American Steel and Wire Company of New Jersey acquired the American Steel and Wire Company of Illinois and many other wire firms, gaining a virtual monopoly over the country's wire

**United States Department of the Interior  
National Park Service****National Register of Historic Places  
Continuation Sheet**

Iron and Steel Resources of Pennsylvania, 1716-1945

E 69

Section number \_\_\_\_\_ Page \_\_\_\_\_

production. In April, 1899 the American Sheet Steel Company was organized by combining numerous sheet mills, and it gained control of seventy per cent of the nation's sheet manufacturing capacity. The National Tube Company, organized in June, 1899, had approximately seventy-five per cent of United States pipe and tube capacity.<sup>37</sup>

These mergers culminated in 1901 with the formation of the United States Steel Corporation. John Pierpont Morgan and his investment banking house in New York created this gigantic corporation by joining the Carnegie Company, the Illinois Steel Corporation, the American Steel and Wire Company of New Jersey, the National Tube Company, the American Sheet Steel Company, and numerous other iron and steel companies. As the largest firm in the nation, the United States Steel Corporation controlled almost sixty per cent of the nation's iron and steel output. Because the firms joined together in the United States Steel Corporation had integrated vertically and horizontally, the new organization owned seventy-three blast furnaces, steel works, rolling mills, vast ore and coal holdings, 112 steamships for hauling raw materials, and a thousand miles of railroad for transporting materials. Morgan formed this corporation in part to control competition in the iron and steel industry. In particular, Andrew Carnegie had threatened to build a new tube plant and undercut the National Tube Company, in which Morgan had invested. Carnegie willingly sold his firm because he faced stiff competition from his next largest rival, the Illinois Steel Corporation. In addition, as Peter Temin states, Morgan and other investors created the United States Steel Corporation in order to profit from the act of formation. Securities in the highly capitalized corporation could be sold to the public, generating profits for the initial investors. In profiting from sales of securities as well as controlling competition, the United States Steel Corporation led the nation's growth of big business and mergers at the turn of the century.<sup>38</sup>

Growing steel firms also tried to profit by cutting labor costs, which was a critical method of reducing overall production costs and meeting competition. To plant managers "labor was primarily an item of cost," and "the proportional reduction of labor cost was the principal achievement of the economizing drive."<sup>39</sup> United States iron and steel manufacturers decreased labor costs as a proportion of total expenses from approximately twenty-two per cent in 1880 to eighteen per cent in 1900. Pennsylvania manufacturers had a slightly lower proportion of labor costs than other American employers, reducing labor charges from about twenty-one per cent in 1880 to seventeen per cent in 1900. One of the primary ways in which Pennsylvania and other employers decreased labor costs was by increasing the productivity of workers. They greatly increased the amount of product manufactured by each worker. In the

**United States Department of the Interior  
National Park Service****National Register of Historic Places  
Continuation Sheet**

Iron and Steel Resources of Pennsylvania, 1716-1945

E 70

Section number \_\_\_\_\_ Page \_\_\_\_\_

United States one worker on average made forty tons of iron or steel in 1880, and 133 tons in 1900. Again, Pennsylvania employers outpaced the rest of the nation slightly, increasing tons made by one worker on average from fifty-five in 1880 to 138 in 1900. Thus, although the number of Pennsylvania iron and steel wage earners grew from 57,952 to 110,864 between 1880 and 1900--a jump of ninety-one percent--the tons of products burgeoned from 3,229,168 to 15,290,711 between the same years, for an increase of 374 per cent.<sup>40</sup>

Employers increased workers' productivity in large part through technological innovations that reduced the number of employees needed to perform a task, and that increased the pace of work for those remaining. Skip hoists and ore bridges eliminated the need for gangs of laborers to charge iron blast furnaces. Casting ingots on cars, and using the Jones mixer replaced more workers at iron and steel furnaces. Lifting tables and rollers replaced gangs of men who had lifted and carried hot metal by hand, and moved materials through rolls far faster than manual labor could. These technological changes ended some of the most dangerous work in iron and steel mills, such as hand loading iron furnaces which spewed out searing, poisonous gases. But these innovations also speeded up work and often increased physical demands placed on employees.<sup>41</sup>

Employers also enforced discipline and set hours to boost productivity. Work rules, backed by fines and firings, were designed to ensure steady work, attentiveness, and efficiency in use of machinery and material. At the Carnegie Company in 1892, workers were forbidden to drink liquor on the job and had to obtain their foreman's permission before taking leave. Employees were also "required to exercise economy in the use of all material, and to keep the machinery and works neat and clean." Supervisors, including gang foremen called "pushers," drove their men to work harder. Charles Schwab drove workers at the Edgar Thomson Works in part by appealing to employees' competitiveness. Seeking to improve output at a blast furnace, he wrote in chalk on a large piece of steel plate the number of heats done one day at the furnace. Subsequent shifts, after learning what the number meant, chalked higher numbers up as they increased the number of heats done each day. At first employers set three shifts of eight hours each for most workers, keeping the plant running all day and avoiding completely wearing out employees who struggled to keep pace with machinery. Only a minority of workers, such as some men at blast furnaces, worked twelve hour shifts. But by the 1890s, as machinery completely outpaced workers, the twelve hour shift spread through other sections of the mills. Men at blast furnaces labored seven days a week; those in other sections usually labored six days, having Saturday evening through Sunday afternoon off.<sup>42</sup>

United States Department of the Interior  
National Park ServiceNational Register of Historic Places  
Continuation Sheet

Iron and Steel Resources of Pennsylvania, 1716-1945

Section number       E       Page       71      

Although workers' productivity increased, employers did not raise their pay proportionately. The average annual wages for a Pennsylvania steel worker grew from \$433.05 dollars in 1880 to \$558.42 in 1900, for an increase of twenty-nine percent, far below the rapid rise in their annual output of iron and steel. Employers determined wages largely by trade conditions for iron and steel and the supply of labor. As demand for iron and steel rose, employers usually increased wages in order to attract more workers and fill growing orders. During economic downturns, employers cut wages as orders declined. Employers also quickly shut down plants during business depressions, preferring to either run their mills at or near capacity or not at all. Shut downs, of course, threw thousands of employees out of work at a time when unemployment insurance and public welfare payments did not exist. Wages in the iron and steel industry were highly sensitive to changing trade conditions and labor supply, varying more than in most other American industries generally. Wage rates in the nation's iron and steel industry, for example, fell some sixty per cent from the early 1890s to the economic depression of the mid-1890s, and then rose the same sixty per cent by the end of the decade. Wage rates also varied by geographic area, company, and skill level. Wage levels in the late nineteenth century were highest in the Pittsburgh and Chicago areas. Pennsylvania's overall wage rates in 1880 and 1900 were nine percent and two percent higher, respectively, than in the rest of the nation. Skilled workers, such as rail mill rollers and Bessemer <sup>43</sup>vessemen, also received higher wages than unskilled laborers.

Skilled employees countered employers' labor management policies, particularly their wage reductions, by joining together in unions. Powerless as individuals against large corporations, skilled workers found strength in collective action. The Sons of Vulcan, a union of iron puddlers formed in Pittsburgh in 1858, protested for higher wage rates and became, by the early 1870s, one of the foremost unions in the United States. Rollers in Chicago organized the Associated Brotherhood of Iron and Steel Heaters, Rollers, and Roughers in 1862; this organization spread to Pittsburgh by 1875. A third union originating in Chicago, the Iron and Steel Roll Hands of the United States, took the initiative in 1876 in combining these three organizations into the Amalgamated Association of Iron and Steel Workers. The Amalgamated Association included the skilled craftsmen in the iron and steel industry, and quickly became the principal union in the industry. The organization prospered through the 1880s, reaching its apex in 1891 with 24,000 members, or about two thirds of the eligible skilled workers. It was strongest in iron mills west of the Alleghenies, and weaker in steel plants, particularly those to the east. In the Pittsburgh area, the Homestead plant of the Carnegie Steel Company and a mill owned by the

United States Department of the Interior  
National Park ServiceNational Register of Historic Places  
Continuation Sheet

Iron and Steel Resources of Pennsylvania, 1716-1945

E 72

Section number \_\_\_\_\_ Page \_\_\_\_\_

Jones and Laughlin Steel Company were unionized, but not the Duquesne plant or Edgar Thomson Works after 1885. The union failed to organize effectively steel mills east of the Alleghenies. For example, an Amalgamated Association Lodge begun at Steelton in 1890 died the next year.

The Amalgamated Association was frequently quite powerful through the 1880s in those mills it organized. The plant lodges concentrated on maintaining wage rates, and during the 1880s successfully struck a number of times for better wages. The lodges also developed sometimes elaborate work rules governing what members did in the plants. Referring especially to the work rules, a prominent Carnegie Company official charged years later that the local Amalgamated Association lodge had run the Homestead plant, a statement that old workers supported. However, the union also accommodated technological change and did not challenge employers over issues that other contemporary unions were fighting for. The Amalgamated Association did not attempt to retard technological advances that eliminated jobs in plants it had organized. It similarly did not fight for wage raises that kept pace with productivity increases. The union was also largely indifferent to the American Federation of Labor's crusade for the eight hour work day.

Despite the Amalgamated Association accommodations, mill owners eventually required the union's complete submission. Manufacturers concluded that the union interfered with their control of plants and their efforts to gain maximum production efficiency. Employers battled the union in order to decrease costs, and to eliminate work rules that hampered reorganization and mechanization of work. Contention over these issues, particularly wage rates, climaxed in the summer of 1892 at the Homestead mill of the Carnegie Company. Andrew Carnegie and Henry C. Frick resolved to smash the union lodge at Homestead. Their firm demanded wage cuts for skilled workers, telling the employees that technological improvements had increased output and reduced work. The union responded that the pay cuts were too deep, and rejected the company's ultimatum that the union either except the proposed rates or face a plant shutdown. Frick closed the plant on July 1, locking out the skilled workers and the rest of the work force who supported them. Employees in turn ran out of town sheriff's deputies appointed to guard the plant, and occupied the plant in order to prevent strike breakers or scabs from entering the mill. Determined to eliminate the union lodge, Frick hired three hundred Pinkerton detectives, armed them with rifles, and on the morning of July 6, had them floated on two barges to the Monongahela River bank at the edge of the Homestead plant. As the barges drew near shore, a fusilade of shots erupted between the detectives and armed workers inside the plant. The gun battle raged until four in the



United States Department of the Interior  
National Park ServiceNational Register of Historic Places  
Continuation Sheet

Iron and Steel Resources of Pennsylvania, 1716-1945

E

73

Section number \_\_\_\_\_ Page \_\_\_\_\_

afternoon, when the Pinkertons, having suffered three dead, surrendered to the workers. When the detectives came ashore, they were forced to run a gauntlet of Homestead men and women who were enraged by the death of seven workers. The workers continued their strike, but Frick remained steadfast. He succeeded in having the governor of Pennsylvania send state militia into Homestead on July 12 and take control of the town under martial law. With the protection of the militia, Frick reopened the plant with strike breakers and some 800 of the original 4,000 employees who were reinstated. The strikers had won the battle at Homestead, but had lost the war.<sup>46</sup>

The fighting at Homestead had profound repercussions for both the Amalgamated Association and the organized labor movement in the United States. The violence sparked heated debate in Congress and newspapers across the country over what such warfare between employers and employees meant for the country. Some labor proponents argued that the Pinkerton detectives were a private army controlled by industrialists, and workers had the right to resist such an army in defense of their jobs and homes. Other opponents of organized labor condemned the Homestead workers, claiming that the Carnegie Company, like any other employer, had the right to hire whom ever they desired and could protect those they hired. Both contemporary observers and later labor historians have cited Homestead as taking "its place in the annals of labor history as one of the great battles for workers' rights." More immediately, the failed strike at Homestead spelled the rapid decline of the Amalgamated Association in the 1890s. Emboldened by the success of the Carnegie Company against the union, other firms began refusing to sign contracts with the Amalgamated Association. By 1900 no large steel plant in western Pennsylvania recognized the union. Employers also used a battery of other weapons to defeat the union, including hiring spies to work among employees and report union activities, firing union members, requiring workers to sign contracts forbidding them from joining the union, and blacklisting workers who did join a union. The end of the Amalgamated Association's effectiveness came in 1901 when it called a strike against the United States Steel Corporation for better wage rates and union recognition in non-union mills. The walk out ended in a miserable defeat for the union, and left the union representing workers in only a handful of mills, most of them to the west of Pennsylvania.<sup>47</sup>

The deskilling of its members also helped cause the decline of the Amalgamated Association. The union's skilled members were in short supply up to the 1880s. The most potent weapon these men could wield against employers was to withhold their labor during strikes. As David Brody states, skilled workers "had been strong, even arrogant, in their indispensability." Yet by the 1890s mechanization was eliminating skills

United States Department of the Interior  
National Park ServiceNational Register of Historic Places  
Continuation Sheet

Iron and Steel Resources of Pennsylvania, 1716-1945

E

74

Section number \_\_\_\_\_ Page \_\_\_\_\_

needed in the iron and steel plants. For example, earlier rolling mills had required skilled men to catch and pass hot steel through the rolls. With the invention of roll trains and lifting tables, these skilled men were no longer needed. As more skilled positions were eliminated, the supply of skilled workers grew, undercutting their indispensability and the strength of the Amalgamated Association. Employers found that they could more easily replace skilled workers who struck or joined the union.

The composition of the work force in Pennsylvania's and America's iron and steel industry changed in another significant way during the late nineteenth century. A rising tide of southern and eastern European immigrants and blacks increasingly took the unskilled, lower paying jobs in the mills. Before the 1880s native born American, British, Irish and German workers held the great majority of positions, both skilled and unskilled. By the late 1880s Slovaks, Poles, Croats, Serbs, Magyars, Italians and others were flowing into the mills of Pennsylvania. Blacks, who had begun working in Pennsylvania steel mills during the 1870s, increasingly found jobs in the industry during the 1880s and 1890s. In Steelton, for example, the number of foreign residents rose from 231 out of 2,447 total population in 1880 to 2,992 out of 12,086 in 1900. The number of blacks in the population also rose greatly, from 202 in 1800 to 1,244 in 1900. As the Steelton plant expanded, more eastern and southern European immigrants and blacks came to Steelton to take unskilled jobs. Southern and eastern European immigrants were often pushed from their homeland by poverty stemming from a variety of causes, including lack of farmland for sons as population increased, and droughts and diseases that killed livestock or crops. At least some blacks were pushed off Southern farms by poverty, frequently created in sharecropping. These new workers were pulled to iron and steel mills in Pennsylvania by the prospect of wages better than the livelihoods they had earned in their homelands. Even low wages offered for unskilled work in the mills were generally better than what they had earned before. Southern and eastern European immigrants who flocked to the mills were also overwhelmingly single men through the 1890s, and came to earn money that they could send or bring back to their homelands. The low wages were enough to support themselves and save for family back home, as long as they could work steadily. Thus immigrant workers through the 1890s tended to be less concerned with the wage rate than with obtaining steady work. When steel mills closed during economic downturns, southern and eastern European immigrants were much more likely to migrate elsewhere in search of work than Britons and native born Americans were.

**United States Department of the Interior  
National Park Service****National Register of Historic Places  
Continuation Sheet**

Iron and Steel Resources of Pennsylvania, 1716-1945

E 75

Section number \_\_\_\_\_ Page \_\_\_\_\_

Eastern and southern European immigrants and blacks confronted hard adjustments to life in Pennsylvania plants and mill towns. For first-time entrants into the mills, work could be bewildering if not frightening. To the uninitiated steel plants could be a mass of seeming confusion and terror. Supervisors spoke languages unknown to eastern and southern European immigrants, smoke often billowed through the air, and fiery metal passed nearby through huge machines. Even after becoming more accustomed to their surroundings, these newer immigrants still had higher accident rates than the English-speaking workers in the mills did. Outside the mills blacks and eastern and southern European immigrants lived in the worst housing in ethnically and racially segregated neighborhoods. Their houses were often poorly ventilated, in bad repair, and overcrowded. Sanitation was frequently poor, with often overflowing outhouses located behind the houses. For example, in Steelton the Pennsylvania Steel Company erected a neighborhood of shanties for blacks and Slavs arranged in blocks of five to ten. Each shanty had one room about seven feet by twelve feet and ventilated by a small window. According to one observer, "the filth in and about the place was intolerable." Native born, German and British residents were frequently critical of if not openly hostile to the newcomers. Native born Americans derogatorily called eastern and southern European immigrants "hunkies," and often blamed the immigrants for the slums in their towns, even though private and company landlords were responsible for much of the substandard living conditions. Native born residents also criticized the newer immigrants for heavy drinking, and in some mill towns organized temperance organizations and police forces to help control the growing immigrant populations. Local magistrates, who were paid by fees levied on minor civil and criminal cases, sometimes took advantage of immigrants ignorant of the legal system by trying them on dubious charges.

Eastern and southern European immigrants and blacks, faced with such discrimination, turned inward to their own social and religious institutions for comfort, assistance and identity. In the process the first generation of southern and eastern European immigrants often developed a stronger consciousness of their ethnicity than they had had in Europe. By 1901 immigrants in Pennsylvania steel towns had begun establishing fraternal societies which offered burial, sick and unemployment benefits, as well as a place to socialize. Immigrants also conducted public festivities such as parades and the celebration of the Orthodox Christmas. In addition, eastern and southern European immigrants and blacks organized ethnic churches which became the central institution in their lives outside the mills. Churches offered spiritual guidance to peoples who were often fervently religious; they also perpetuated Old World languages and traditions through their services

**United States Department of the Interior  
National Park Service****National Register of Historic Places  
Continuation Sheet**

Iron and Steel Resources of Pennsylvania, 1716-1945

E 76

Section number \_\_\_\_\_ Page \_\_\_\_\_

and festivities. Priests and ministers might offer assistance in secular affairs as well, such as aiding those in financial need. In Steelton, for example, Croats and Slovenes who felt isolated and alone in a new land joined together to form social and religious institutions. At the suggestion of a visiting Slovene priest in 1893, the Croats and Slovenes organized a society which provided sick and death benefits. In 1898 they created their own church, St. Mary's Croatian-Slovenian Church. Blacks in Steelton attended an African Methodist Episcopal Church and two Baptist churches formed between 1871 and 1895. A Negro Widows and Orphans Committee raised money for the needy, while the all-black Odd Fellows fraternal order provided sick and death benefits. They also created the Home Club of Steelton to help advance the education of black children who were required to attend an all-black school in town.<sup>51</sup>

Steel companies generally dominated the other institutions in mill towns not created by immigrant and black groups. Local steel company executives often led local governments. They frequently held public office in steel towns, such as Steelton, where Pennsylvania Steel Company superintendents presided over the borough council and the school board from the mid-1880s to the mid-1890s. Local executives had considerable influence over local politicians not employed by the company, since the steel mill was usually by far the largest employer in town, and because steel firm executives often befriended local politicians in the churches, social clubs and other institutions they commonly attended. Steel firms at times sought to gain a town's allegiance through their largesse. In 1881 the Pennsylvania Steel Company donated a \$100,000 school building to the town, and also helped pay part of the school superintendent's salary. Steel firms exerted considerable influence over local businesses, particularly as the strength of the Amalgamated Association waned. During the 1880s and early 1890s local businessmen sometimes supported the union during strikes, in part because they feared that opposing a powerful union could mean loss of union customers. But as the union declined local businessmen frequently allied with steel company executives who wielded greater economic power. In addition to their other powers, in some mill towns the steel company had the most control of any local developer over housing. A few firms built sizeable tracts of single, duplex and row housing and shanties for workers. Shortly after the Homestead strike in 1892 the Carnegie Company acquired the site of the Pittsburgh City Poor Farm adjoining Homestead and built houses for sale to employees. The Apollo Iron and Steel Company sold land and advanced money for houses to employees in Vandergrift. Many of the row houses in Steelton, particularly on the West side near the Susquehanna River, were erected by the Pennsylvania Steel Company. Steel firms built houses and sold or

**United States Department of the Interior  
National Park Service**

**National Register of Historic Places  
Continuation Sheet**

Iron and Steel Resources of Pennsylvania, 1716-1945

E 77

Section number \_\_\_\_\_ Page \_\_\_\_\_

---

rented them to employees in order to strengthen workers' attachment to the employer and decrease protests and turnover of the labor force.<sup>52</sup>

Thus by 1901 iron and steel companies had brought enormous changes to the industry and mill towns scattered across Pennsylvania. Huge firms, including the largest corporation in the country, dominated the Pennsylvania iron and steel industry. These companies had instituted wholesale technological changes that helped transform manufacturing plants into gigantic facilities churning out huge quantities of iron and steel products. Iron and steel firms had also succeeded in all but vanquishing organized labor from their mills. Many of these changes effected by 1901 enabled Pennsylvania mills to lead the nation in iron and steel production through World War II. However, in maintaining their leadership, the Commonwealth's mills had to contend with further transformations after 1901, including the development of new products for a changing economy, and the resurgence of organized labor.

United States Department of the Interior  
National Park Service**National Register of Historic Places  
Continuation Sheet**

Iron and Steel Resources of Pennsylvania, 1716-1945

E

78

Section number \_\_\_\_\_ Page \_\_\_\_\_

**OLIGOPOLY, THE GREAT DEPRESSION, AND THE RISE OF  
ORGANIZED LABOR, 1902-1945**

A small group of giant companies dominated the iron and steel industry in Pennsylvania and the United States between 1902 and 1945. Much of the competition endemic in the industry during the later nineteenth century abated as firms, led by the United States Steel Corporation, cooperated to set prices and ensure markets for manufacturers. The most important market became sheet steel produced for automobiles which burgeoned in number during the early twentieth century. Steel companies improved machinery and production processes in order to make better quality sheet and other types of steel, as well as to increase output and efficiency. Growing demand for sheet steel, and for other heavier products such as structural steel, particularly during the two World Wars, led to prosperity for much of the period. The Great Depression, however, marked the worst economic downturn the steel industry experienced before 1945. Large steel companies, including those in Pennsylvania, suffered financial losses during the early and mid-1930s, and they recovered only slowly until World War II restored full production. For much of the period workers remained quiescent as employers instituted welfare measures designed to maintain labor-management stability. Yet New Deal legislation enacted during the Great Depression spurred the rise of organized labor. For the first time an industry-wide union, the United Steel Workers of America, formed to challenge effectively the power of the giant steel corporations.

Iron and steel companies in Pennsylvania and the nation continued to consolidate after 1901, furthering oligopoly in the industry. By 1917 the small group of firms that would lead the industry for a half century were firmly entrenched in economic power. The twelve largest firms organized by 1917 were twelve of the thirteen largest steel companies operating in 1967. Most of these firms were heavily integrated backwards from production, owning ore and coal mines, coking facilities, transportation facilities, as well as iron blast furnaces, steel furnaces and rolling mills. Few were integrated forward into fabricating steel products from the steel they manufactured. The United States Steel Corporation was by far the largest corporation in the industry. Even though its share of production declined after 1902, the United States Steel Corporation still made thirty-four per cent of the steel ingots manufactured nation-wide in 1940. The corporation mined huge quantities of iron, coal, and limestone, produced its own coke, transported these raw materials to mills, and made millions of tons of iron and steel ingots, castings, and rolled products. The company acquired other iron

United States Department of the Interior  
National Park Service

# National Register of Historic Places Continuation Sheet

Iron and Steel Resources of Pennsylvania, 1716-1945

E 79

Section number \_\_\_\_\_ Page \_\_\_\_\_

---

and steel firms such as the Tennessee Coal, Iron and Railroad Company, and expanded old mills and built new ones, such as a gigantic new plant constructed at Gary, Indiana between 1906 and 1911. The United States Steel Corporation was the most important steel firm in Pennsylvania, especially western Pennsylvania, with large mills located by 1940 at Duquesne, Homestead, Braddock, Dravosburg, among other places in the Pittsburgh area.<sup>1</sup>

The Bethlehem Steel Corporation, organized from the Bethlehem Iron Company in 1899, became the second largest steel firm in the nation by 1920, and the second most important company in Pennsylvania, especially eastern and central Pennsylvania. This firm pursued the most ambitious corporate acquisition program in the industry during the 1910s and 1920s. In an effort to diversify its steel production, the Bethlehem Steel Corporation purchased first in 1916 the Pennsylvania Steel Company with its Steelton and Sparrows Point plants. In 1922 it acquired the Lackawanna Iron and Steel Company located outside Buffalo, New York. This firm had moved from Scranton to Buffalo by 1902. In 1923 the Bethlehem Steel Corporation acquired the Midvale Steel and Ordnance Company, including the Cambria Steel Company plant that Midvale Steel and Ordnance Company had acquired in Johnstown, but not its ordnance plant in Philadelphia. Through such acquisitions, the Bethlehem Steel Corporation greatly increased its production capacity, manufacturing sixteen per cent of the nation's steel ingots in 1940. It dominated steel production to the east of the Pittsburgh area in Pennsylvania, with large plants in Bethlehem, Steelton, and Johnstown. Few other steel companies could challenge the leadership of the Bethlehem Steel Corporation or United States Steel Corporation in the state or nation. Republic Steel Corporation, the third largest steel manufacturer in the nation, manufactured only six per cent of the steel ingots made in 1940, and concentrated its plants in Ohio. The Jones and Laughlin Steel Corporation, formed in 1900 from the merger of Laughlin and Company, Ltd., and Jones and Laughlins, Ltd., had plants in Pittsburgh, including South Side, and a large plant in Aliquippa, constructed and expanded after 1907. Despite its large plant in Aliquippa, the Jones and Laughlin Steel Corporation overall was considerably smaller than the two leading firms in the state and nation.<sup>2</sup>

Steel firms smaller than the Jones and Laughlin Steel Corporation usually were either swept up in the mergers of the early twentieth century or went out of business. In Coatesville, Chester County, for example, the Worth Brothers erected in 1881-1882 an iron plate mill that rolled iron purchased from others. They began rolling steel in 1885, and built a steel works in the 1890s. By the early twentieth century the firm produced its own pig iron and made very wide steel plates. But

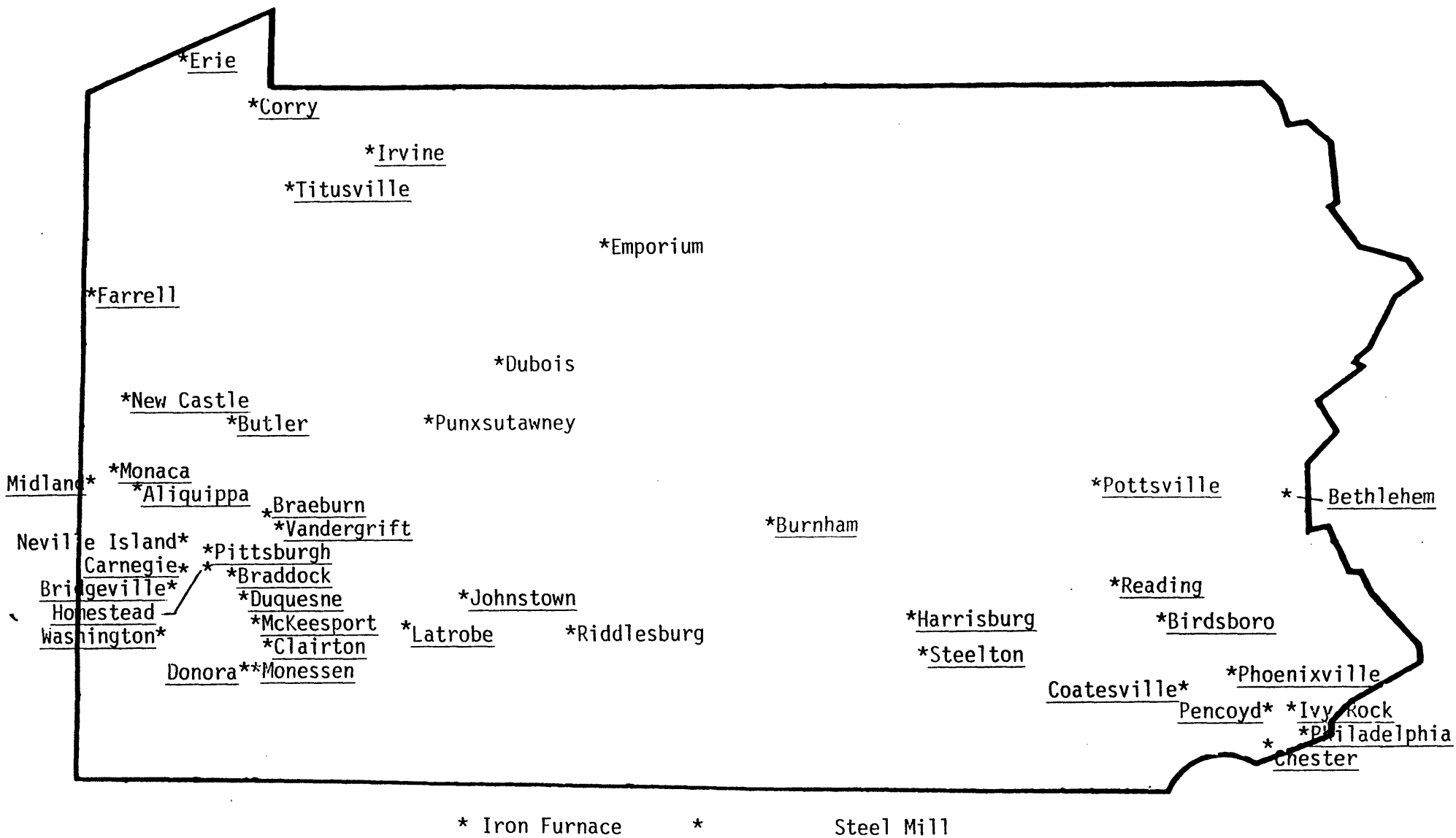

Locations of iron and steel plants in Pennsylvania, 1930. (Source : American Iron and Steel Institute, Iron and Steel Works of the United States and Canada (New York: 1930), pp. 393-413.)



United States Department of the Interior  
National Park ServiceNational Register of Historic Places  
Continuation Sheet

Iron and Steel Resources of Pennsylvania, 1716-1945

E 81

Section number \_\_\_\_\_ Page \_\_\_\_\_

during World War I the Worth Brothers plant was acquired by the Midvale Steel and Ordnance Company, which in turn was swallowed up by the Bethlehem Steel Corporation. Only a few smaller steel companies survived independently of the large firms. The Lukens Steel Company, also located in Coatesville, was one of these firms. Begun in Coatesville in 1810 as an iron rolling mill, the Lukens firm began rolling steel plate in the 1880s, and built an open hearth furnace in 1891. It erected in 1903 a 140-inch wide steel plate mill, and in 1917-1918 a 204-inch rolling mill, expanded to 206 inches in 1919. The 206-inch rolling mill was the largest plate mill in the world for over forty years, and could produce specialized products such as one piece heads for large marine steam boilers. The Phoenix Iron and Steel Company in Phoenixville, Chester County, was established in 1783 to produce iron, made its first steel in 1889, and survived through the early twentieth century by rolling cold steel.

The large steel companies, particularly the United States Steel Corporation, led the industry in collusion in order to end cutthroat competition and ensure steady profits and markets. With the support of J.P. Morgan, former Judge Elbert H. Gary became head of the United States Steel Corporation in 1903. He sought to end what he called the "bitter, relentless, overbearing, tyrannical conduct, calculated to drive out the weak," that had characterized the iron and steel industry in the late nineteenth century. Since his firm was by far the largest in the industry, he wanted to avoid cutthroat practices such as driving competitors out of business that might bring prosecution of the United States Steel Corporation under the federal Sherman Antitrust Act, passed in 1890. As a staunch Methodist and moralist, his ethics also led him to avoid such competition. Other executives who had risen in the industry during the late nineteenth century at first continued to advocate unrestrained competition. Charles Schwab, who resigned as president of the United States Steel Corporation in 1903 and gained control of the Bethlehem Steel Corporation by late 1904, began in 1905 to aggressively expand the Bethlehem Steel Corporation's production facilities and markets. Yet Judge Gary and a financial panic in 1907-1909 convinced other steel company executives to cooperate. Demand for iron and steel products fell in 1908 and early 1909, leading a number of companies to slash their prices. At first Judge Gary resisted cutting the United States Steel Corporation's prices, but as other firms failed to cooperate, the United States Steel Corporation lowered its prices and began rapidly capturing more business. Confronted with such ruinous competition, other firms quickly learned the virtue of cooperation.

Judge Gary and the United States Steel Corporation led the industry into several forms of collusion. Judge Gary held a series of dinners at

**United States Department of the Interior  
National Park Service****National Register of Historic Places  
Continuation Sheet**

Iron and Steel Resources of Pennsylvania, 1716-1945

E 82

Section number \_\_\_\_\_ Page \_\_\_\_\_

which leading steel company executives discussed issues facing the industry, including cooperation. In 1909 the dinners resulted in the organization of the American Iron and Steel Institute, which formalized the lines of communication and cooperation developed during the dinners. Most steel producers also agreed by 1914 to the Pittsburgh Plus pricing system. Standard prices for steel made throughout the country were fixed according to the prices of steel made in Pittsburgh mills. No matter where their plants were actually located, companies charged the Pittsburgh price plus the transportation charge from Pittsburgh to their customer. For example, a Chicago steel mill manufacturing rails for a customer in Milwaukee charged the price for rails given in Pittsburgh, plus the freight rate from Pittsburgh to Milwaukee. Since the rails were actually shipped a shorter distance, the transportation charges included "phantom" freight charges. Such plants could keep the phantom charges as profit or reinvest the money in plant expansion and modernization. Although Pittsburgh mills were not able to reap phantom freight charges, the Pittsburgh Plus pricing system enabled them to compete throughout the United States since customers usually paid the same price no matter how far away from Pittsburgh the manufacturer was. The Pittsburgh Plus pricing system was abandoned in 1924 in large part because customers protested the phantom freight charges. It was replaced by a multiple point pricing system in which prices were fixed according to steel prices quoted at multiple locations around the nation, and freight rates were set from these points. This multiple point pricing system had the potential to restrict Pittsburgh mills from distant markets. However, most mills outside Pittsburgh generally quoted higher prices, lessening the harmful effect on the Pittsburgh mills and enabling them to continue selling over a wide area.

This cooperation, and even more importantly, rising demand brought prosperity to the iron and steel industry during much of the period. With the notable exception of the 1908-1909 slump, steel production in the Commonwealth and nation soared between 1902 and 1918. Population growth and the rapidly expanding automobile, electrical, and oil and gas industries contributed greatly to increasing demand for steel. By 1913 national output of steel far outstripped the manufacture of iron. World War I further increased steel purchases, particularly heavy steel such as armor plate for ordnance. Pennsylvania mills, and particularly Bethlehem Steel Corporation plants, tended to concentrate more on manufacturing heavy steel products than plants in other states did, and often reaped handsome profits during World War I. The end of war-time contracts brought a downturn in the industry in 1919, but production on the whole rebounded during the 1920s. The rapid expansion of the automobile, appliance, construction, electrical and oil and gas industries continued increasing demand for steel. Between 1900 and 1929

**United States Department of the Interior  
National Park Service****National Register of Historic Places  
Continuation Sheet**

Iron and Steel Resources of Pennsylvania, 1716-1945

E 83

Section number \_\_\_\_\_ Page \_\_\_\_\_

iron and steel production in Pennsylvania grew eighty-eight per cent from 15,290,711 tons to 28,890,979 tons. Output in the nation rose 179 per cent from 29,507,860 tons to 82,369,699 tons.<sup>6</sup>

The Great Depression created a financial crisis for the steel industry, as it did for the nation, and steel mills only slowly recovered until World II sent output soaring to record volumes. Demand for steel abruptly dropped in 1930-1932 as major consumers of steel, such as automobile manufacturers and the construction industry, sharply cut back orders. Steel production nation-wide fell to twenty per cent of capacity in 1932, when the industry reached its nadir. This decline represented the lowest steel ingot production since 1901. Production slowly began to recover by the mid-1930s. Such a drastic fall in production meant that steel companies could not profit from as many sales, and could not achieve the same economies of scale they gained when operating at or near capacity. Thus many steel companies in Pennsylvania and the nation suffered financial losses during the early to mid-1930s. The United States Steel Corporation weathered three years of large losses in 1932-1934, while the Bethlehem Steel Corporation suffered smaller losses. National production recovered to seventy-three per cent of capacity in 1937. However, a national recession in 1938 slashed output to forty per cent of capacity, forcing major firms such as the United States Steel Corporation to again take losses. The advent of World War II was the catalyst that restored production to full capacity. New plants were built and old mills expanded to meet phenomenal war time demand, especially for heavy steel products such as plate. A staggering \$2,681,000,000 was invested in new and expanded plants during the war. Almost half of this money was federal government funds spent by the Defense Plant Corporation, which built and owned a number of steel production facilities by war's end. With plants producing at full capacity, steel production peaked forty-one per cent above the level reached in 1929, or almost 500 per cent above the 1900 output. Although production soared during World War II, profits did not keep pace due to an excess profits tax and price freeze mandated by the federal government.<sup>7</sup>

The overall growth in steel output between 1902 and 1945 varied in different product sectors in Pennsylvania and the nation. The most important product sector by 1939, and the fastest growing, was steel for automobiles, particularly sheet steel. As William T. Hogan concludes, the auto industry "brought revolutionary changes in the nature of steel demand and in the quality of the product." The manufacture of automobiles was transformed from a small, largely custom production industry in 1902 to one of the nation's largest mass production industries by the late 1920s. Cars consumed huge quantities of sheet

**United States Department of the Interior  
National Park Service****National Register of Historic Places  
Continuation Sheet**

Iron and Steel Resources of Pennsylvania, 1716-1945

E 84

Section number \_\_\_\_\_ Page \_\_\_\_\_

steel, particularly the all-steel bodies developed by the 1930s. The sheet steel had to be very high quality, possessing an extremely smooth surface to meet consumer expectations, and being ductile enough to be bent into streamlined shapes that car designers were creating by the 1930s. By 1939 the auto industry, and the appliance industry which increasingly bought sheet steel, had boosted sheet production to thirty-four per cent of all the rolled products manufactured by the steel industry. The moving parts of automobiles also demanded high quality, durable alloy steels, particularly during the 1910s and 1920s, before the strength and durability<sup>8</sup> of carbon steel was improved to meet car manufacturers' specifications.

The steel industry met the rising demand for sheet by first expanding production at hand sheet mills, which involved considerable hand labor, and then building much more automated continuous hot strip mills and cold reduction mills. Construction of hot strip mills and cold reduction mills (often operated in tandem) was the only area of significant steel plant expansion during the Great Depression. In 1936-1938, the United States Steel Corporation constructed at Dravosburg, Allegheny County the Irvin Works, which was at the time the most advanced hot strip and cold reduction mill in the nation. The Edgar Thomson Works, located immediately down the Monongahela River from the Irvin plant, was converted from rail production to provide steel slabs for the Irvin Works. As part of a general program of jettisoning outmoded facilities, the United States Steel Corporation abandoned or converted more costly hand sheet mills during the 1930s. For example, it gradually changed its plant at Vandergrift, which had been a major hand sheet mill in the Pittsburgh area, to other products. The Jones and Laughlin Corporation began operating a hot strip mill and cold reduction mill at its Aliquippa plant in 1937. The Bethlehem Steel Corporation erected hot strip and cold reduction mills outside Pennsylvania at its Lackawanna and Sparrows Point facilities. Most hot strip mills, however, were built in Ohio, Indiana and Michigan in order to be nearer the largest consumers of sheet steel, the Detroit automobile manufacturers. Only three of the twenty-one hot strip mills erected in the United States during the 1930s were built in Pennsylvania. With the multiple point pricing system, mills such as the Irvin Works had the competitive disadvantage of higher freight rates to Detroit factories.

Tubes were also an important steel product. In 1939 seamless and welded tubes represented eleven per cent of the total rolled products manufactured by the industry. The largest customer for tubes, particularly seamless tubes that were stronger than welded tubes, was the oil and natural gas industry. During the 1900s to 1920s, large oil fields were discovered and exploited in Texas, Oklahoma, Louisiana,

United States Department of the Interior  
National Park ServiceNational Register of Historic Places  
Continuation Sheet

Iron and Steel Resources of Pennsylvania, 1716-1945

E 85

Section number \_\_\_\_\_ Page \_\_\_\_\_

Wyoming and California. Products refined from crude oil were put to many new uses, especially gasoline for automobiles. Oil companies needed tubes for drilling wells to greater depths, and for transporting oil or gas over long distances, including from Texas to the eastern seaboard. The National Tube Company's plant at McKeesport, Pennsylvania remained one of the nation's most important tube plants.<sup>10</sup>

Structural shapes were also an important steel product. In 1939 structural shapes accounted for eight per cent of the total rolled steel made in the nation. The construction industry was the principal consumer, using more structural shapes for larger buildings and bridges. Huge construction projects such as the Empire State Building and Rockefeller Center in New York, and the Golden Gate Bridge in San Francisco each consumed thousands of tons of columns and beams. Demand for structural shapes was also strong during World War II as the United States military undertook large construction projects. By far the most important manufacturer of structural shapes between 1908 and 1945 was the Bethlehem Steel Corporation. In 1908 it began producing at its Bethlehem plant Grey beams. Named for their inventor, Henry Grey, Grey beams were a revolutionary development in the manufacture and use of structural shapes. They were made of a single piece of steel in the shape of an "I" or "H" and quickly proved superior to beams that were made by riveting the top and bottom flanges to the center upright. Grey beams were cheaper, stronger and lighter, helping architects and engineers to construct taller buildings and bridges with longer spans. By 1920 the Bethlehem Steel Corporation was the country's largest producer of structural shapes. In 1927 the United States Steel Corporation began manufacturing at its Homestead plant a wide flange beam quite similar to the Grey beam. The Bethlehem Steel Corporation sued for patent infringement, eventually settling out of court and licensing the United States Steel Corporation to use its Grey beam patent.<sup>11</sup>

Plate, including armor plate, was also an important product in the steel industry. It comprised eight per cent of total rolled steel products in 1939. Plate was used by a variety of industries including railroad car manufacturers, the construction industry for plate floors in buildings, and ship and armament manufacturers. The demand for plate ballooned during World Wars I and II. In 1905 the Midvale Steel and Ordnance Corporation underbid the Bethlehem Steel Corporation and the Carnegie Company subsidiary of the United States Steel Corporation for armor plate for the United States Navy, leading Charles Schwab to diversify the Bethlehem Steel Corporation into other markets. Government contracts increased from 1909 to 1918, drawing the Bethlehem Steel Corporation back to production of large quantities of plate and steel

United States Department of the Interior  
National Park ServiceNational Register of Historic Places  
Continuation Sheet

Iron and Steel Resources of Pennsylvania, 1716-1945

E 86

Section number \_\_\_\_\_ Page \_\_\_\_\_

for munitions. Then in 1919 this firm returned to commercial steel production, particularly Grey beams. In 1936 the United States Steel Corporation significantly enhanced steel plate production at its Homestead plant with installation of a 100-inch wide plate mill. During World War II this firm expanded plate production at this plant greatly, demolishing an entire ward in Homestead to make way for new production facilities. The Homestead plant became the most important producer of plate in the eastern United States during World War II.<sup>12</sup>

Steel rail production, which was an important sector of the steel industry in 1902, moved west from Pennsylvania and then fell to a minor place in total output. During the early twentieth century the United States Steel Corporation concentrated rail manufacture in Chicago-area plants, which were nearer the major consumers of rails, western railroads. The Chicago area became the principal rail manufacturing center in the nation. Railroads' demand for steel rails plummeted during the 1930s as railroad traffic declined due to the Great Depression and the rising competition of automobile, bus and truck traffic. In 1939 steel rails represented only three per cent of the industry's total rolled steel output. By then only seven plants in the nation were equipped to make heavy steel rails, including the Steelton and Bethlehem plants of the Bethlehem Steel Corporation.<sup>13</sup>

The manufacture of these various steel products required unprecedented stress on high quality. Steel companies developed new technologies to make steel with better quality as well as greater efficiency. Steel manufacturers continued to try to modernize equipment in order to improve throughput and productivity and cut production costs. As Charles Schwab stated, "It was the tearing down, and the throwing away, and watching of costs and putting efficiency into the business that brought success" to the Bethlehem Steel Corporation after 1904. Yet steel firms above all emphasized improving the quality of their steel products. Demand by the automobile industry for better quality sheet and alloy steel has been noted. The construction industry sought a wide variety of structural shapes that were stronger and lighter so taller buildings and longer bridges could be erected. Even in the declining rail sector, railroad companies sought stronger steel rails to carry heavier engines and cars.<sup>14</sup>

The most important technological innovations between 1902 and 1945 were the developments of the continuous hot strip mill and the cold reduction mill to produce large quantities of high quality sheet steel. Before 1924 all sheets over two feet wide were rolled on hand sheet mills. One worker called a roller took a piece of flat steel about one half to one and a half inches thick, and inserted it into a two high

United States Department of the Interior  
National Park ServiceNational Register of Historic Places  
Continuation Sheet

Iron and Steel Resources of Pennsylvania, 1716-1945

E 87

Section number \_\_\_\_\_ Page \_\_\_\_\_

roll stand. Another worker, the catcher, caught the steel coming out the opposite side of the roll stand and passed it over the top of the roll stand back to the roller, who repeated the process until the steel was reduced to the desired thickness. The steel was then reheated, and passed through a second roll stand for finishing. The workers needed great skill to make a uniform sheet of the desired thickness. Between 1922 and 1924 the American Rolling Mill Company developed at its Ashland, Kentucky plant the first hot strip mill in the United States. A steel ingot was reduced in a blooming mill, then cut to width by a shear. The steel passed through seven consecutive roll stands that reduced it to less than one half inch thick and about thirty feet long. Each of the seven roll stands reduced the thickness slightly more than the preceding roll. The steel was then reheated, cut to length, and sent through seven more roll stands which reduced it to a thickness of .0625 to .203 inches. This automatic rolling process eliminated rollers and catchers and greatly increased throughput. Further technological advances enabled strip mills to operate even more quickly and make a more uniform product. At Butler, Pennsylvania the Forged Steel Wheel Company developed four-high roll stands, in which two small work rolls pressing against the steel were supported top and bottom by larger diameter backup rolls. The backup rolls enabled the work rolls to press the steel more thinly than a two-high stand could, decreasing the number of roll stands needed for a strip mill and making a more uniform sheet. By 1927 Ohio strip mills eliminated the need to reheat the steel, creating the first truly continuous hot strip mill. By 1929 laborers at continuous hot strip mills were making as much sheet<sup>15</sup> as thirteen times as many workers using hand mills could manufacture.

Cold reduction mills were developed during the early 1930s to make even thinner and higher quality sheet. In this process a long strip of sheet was cooled to room temperature and then fed through a series of roll stands which exerted tremendous pressure on the sheet. This process rolled sheet thinner, and very importantly, gave sheets a much better surface finish and more ductility than the hot strip mill produced. Steel companies soon began constructing cold reduction mills in tandem with continuous hot strip mills and other processes for finishing sheet. The state-of-the-art Irvin Works opened with an eighty-inch wide continuous hot strip mill, an eighty-four inch wide, three stand, four-high cold reduction mill, and a forty-two inch wide, five stand, four-high cold reduction mill for rolling narrower sheets. The Irvin Works also incorporated temper mills which hardened the sheet, annealing furnaces which heated the sheet to make it more ductile, and a continuous pickling line which cleaned the sheet surface before it passed through the cold reduction mill. This plant also had hot dip

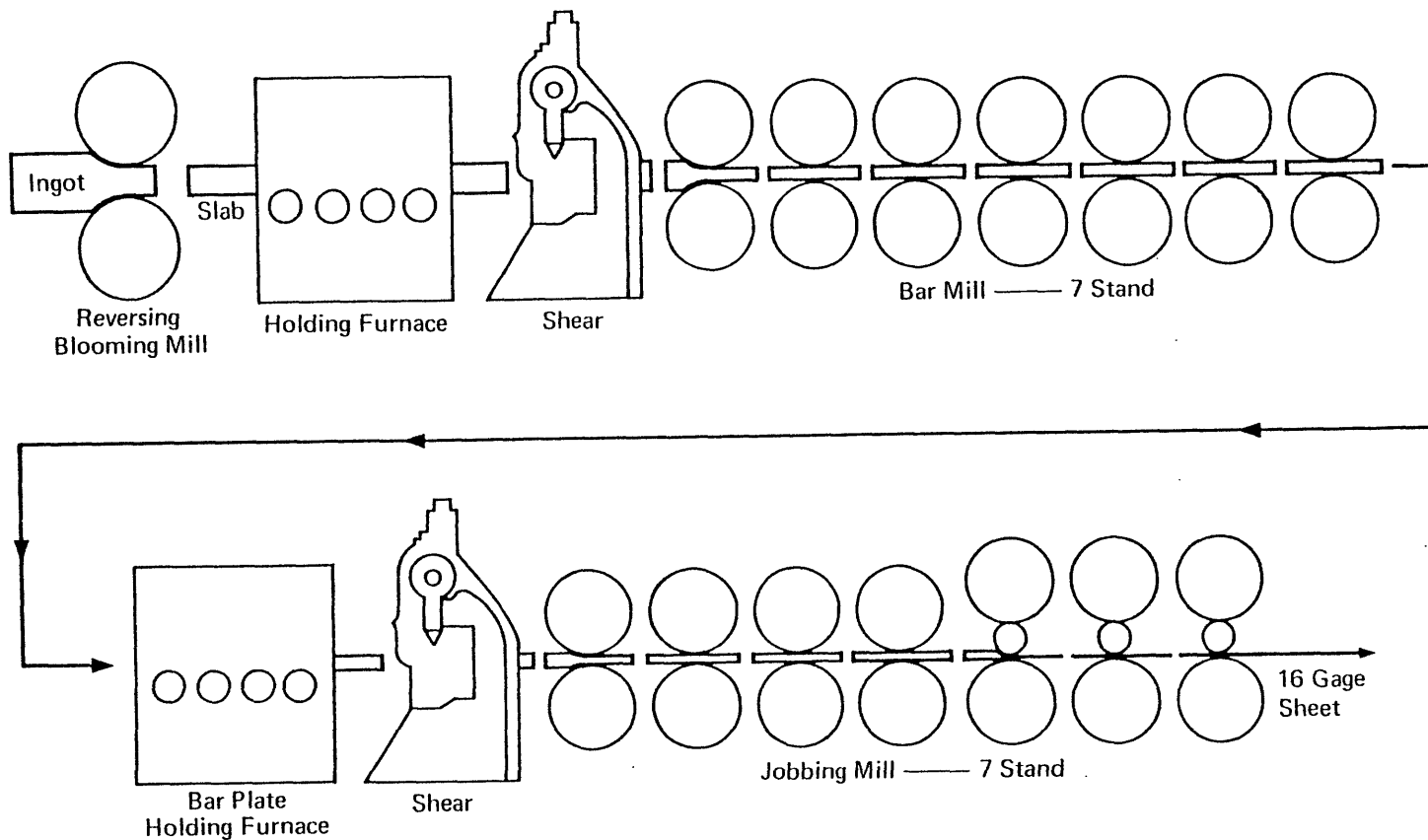

A schematic diagram of the Ashland Strip Mill. Later fully continuous strip mills eliminated the bar plate holding furnace so that steel was passed directly from the bar mill to the jobbing mill. (Source: William T. Hogan, Economic History of the Iron and Steel Industry in the United States (Lexington, MA.: Lexington Books, 1971), 3: 849.)



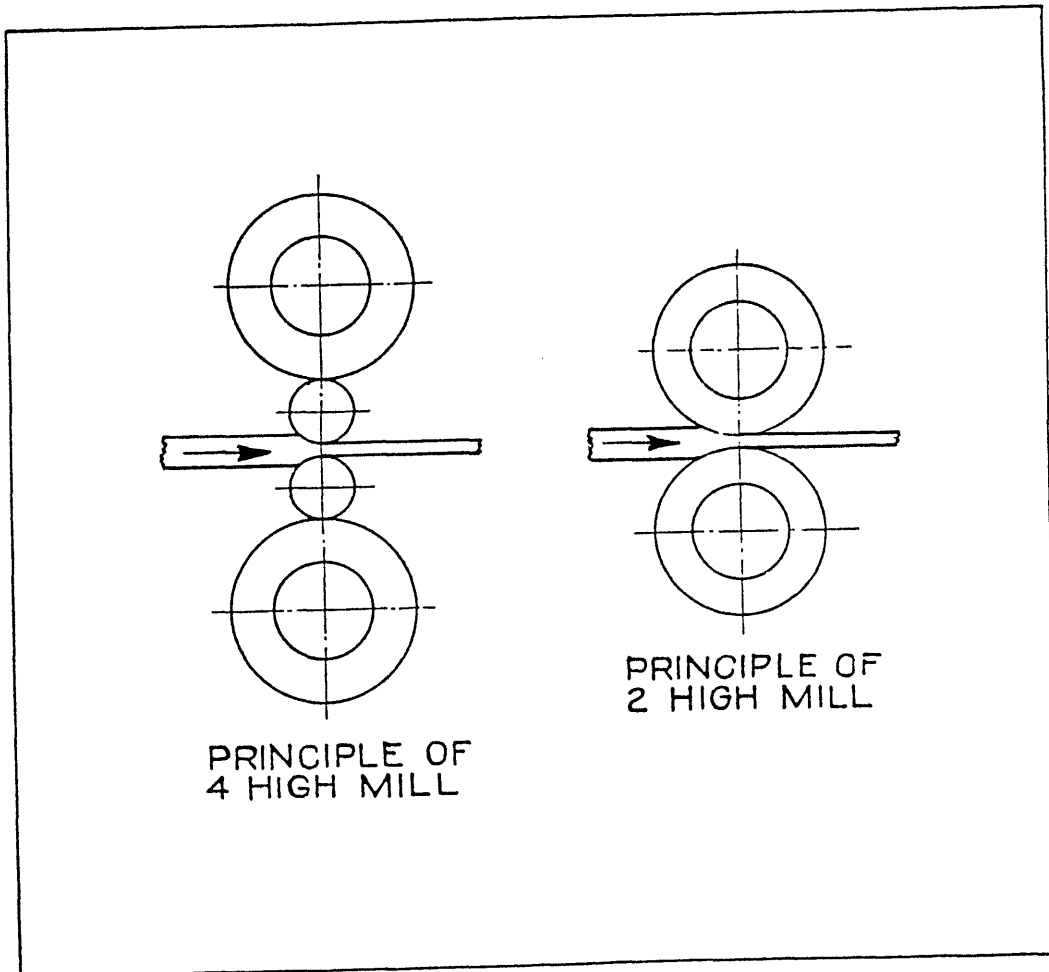

The four-high roll mill, with two work rolls and two larger, backup rolls, compared to the two-high roll mill. (Source: William T. Hogan, Economic History of the Iron and Steel Industry in the United States (Lexington, MA.: Lexington Books, 1971), 3: 854.)

**United States Department of the Interior  
National Park Service**

**National Register of Historic Places  
Continuation Sheet**

Iron and Steel Resources of Pennsylvania, 1716-1945

E 90

Section number \_\_\_\_\_ Page \_\_\_\_\_

---

tinpots in which sheet was coated with tin to make tinplate, used especially for tin cans.<sup>16</sup>

The adoption of electric motors as the prime motive force in steel mills aided the development of hot strip and cold reduction rolling mills. Before the early twentieth century steam engines had been the primary means of driving machinery in steel mills. Huge steam engines could be found in the mills powering roll stands and other machinery. In 1891 at its Homestead plant, the Carnegie Company pioneered utilization of direct current electric motors. In 1905 the Edgar Thomson Works were the first to use electric motors to drive roll stands. By the 1920s alternating current motors had spread widely through steel mills, making steam engines obsolete. Electric motors were more efficient, more reliable and less expensive to operate than steam engines. They were also better able to operate at high and variable speeds, and could be more finely controlled. These last characteristics were essential in hot strip and cold reduction mills where roll stands often ran at high and precisely set speeds in order to feed thinner and thinner sheets from one roll stand to another.<sup>17</sup>

Rolling machinery to manufacture the Grey beam was another major innovation in steel making. Henry Grey, an Englishman who migrated to America in 1870, developed by 1897 a process to produce a wide flange beam from a single piece of steel rather than from several pieces riveted together. Grey recognized the superior qualities of his beam, but at first could not interest any United States companies in investing in his process. In 1905 Charles Schwab inspected a German mill that was successfully manufacturing Grey beams, and decided to erect a Grey beam mill at Bethlehem. This plant included a blooming mill which rolled a steel ingot into a beam blank with the first impressions of an "I" beam. The beam blank then passed through the first Grey mill which had horizontal rollers that pressed the center of the blank down, and vertical rollers that simultaneously shaped the broad, flat faces of the flanges. The steel then passed through a second roll stand with horizontal rolls that shaped the narrow edges of the flanges. After moving back and forth through this first pair of roughing stands, the steel then went back and forth through a second pair of similar finishing stands.<sup>18</sup>

The efficiency and output of steel and iron furnaces also improved. The most important technological development in steel furnaces was the dominance gained by open hearth production. Steel firms continued to construct more open hearth furnaces rather than Bessemer furnaces for the same reasons they had been increasingly adopted before 1902. Open hearth furnaces could use lower cost ores containing varying amounts of

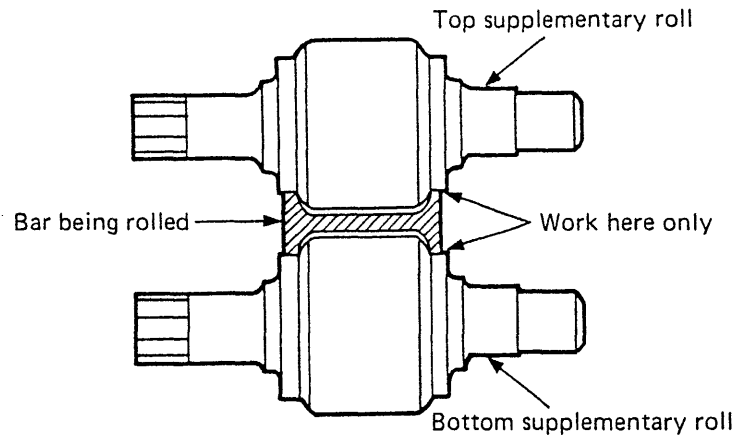
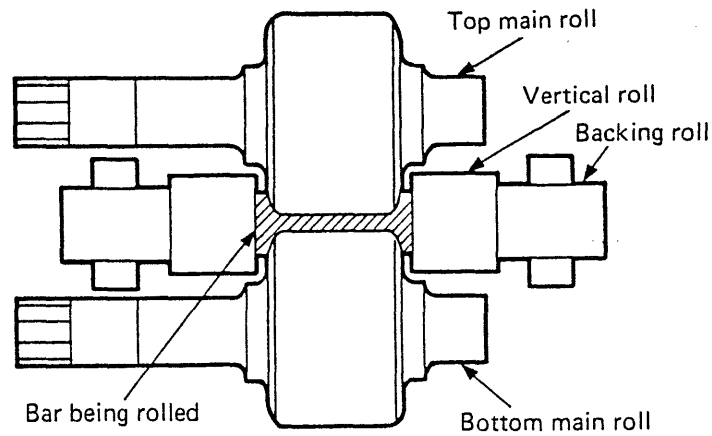

The two roll stands that manufacture a Grey beam. The top diagram shows the first roll mill that depressed the center of the beam and shaped the flanges. The bottom diagram illustrates the second roll stand that shaped only the edges of the flanges. (Source: William T. Hogan, Economic History of the Iron and Steel Industry in the United States (Lexington, MA.: Lexington Books, 1971), 2: 429).

**United States Department of the Interior  
National Park Service****National Register of Historic Places  
Continuation Sheet**

Iron and Steel Resources of Pennsylvania, 1716-1945

E 92

Section number \_\_\_\_\_ Page \_\_\_\_\_

phosphorous than Bessemer furnaces could utilize, they could use more scrap, and they could make better quality steel. Steel firms also gradually increased the size of open hearth furnaces from a national average capacity of 57.5 tons per furnace in 1900 to 115.6 tons in 1942. In addition, the layout and auxiliary equipment of open hearth plants were improved to make them more efficient. By 1920 open hearth furnaces were placed side by side in a row down the center line of an immense rectangular building. On one side of the furnaces was the charging floor, from which materials were loaded into the furnace. Railroad tracks on the charging floor carried charging boxes filled with scrap and other materials to the furnace, and a charging machine picked up the box and dumped the materials into the furnace. An overhead travelling crane carried ladles of molten iron to be poured into the furnace. On the other side was a pit holding ladles or ingot molds into which molten steel poured from the furnace. The pit also contained slag thimbles into which waste slag poured. An overhead travelling crane moved the ladles, ingot molds and slag thimbles into position. Regenerative stoves called checker chambers were located under the charging floor. A large flue connected the checker chambers with a stack. These advanced open hearth furnaces pushed Bessemer converters out of most steel production. By 1939 open hearth furnaces made ninety per cent of the steel produced in Pennsylvania, and ninety-one per cent of the country's steel, while Bessemer converters manufactured only seven and six per cent respectively.

Another important innovation in steel furnaces was the adoption of the electric arc furnace. In 1939 they produced only three per cent and one per cent of steel manufactured respectively in Pennsylvania and America, but they were particularly important for making high quality alloy steels, such as those demanded by the automobile industry. The electric arc furnace was developed first in 1878 when Sir William Siemens built in England an experimental furnace that melted steel with an electric arc. The first commercially successful electric arc furnace began operation in France in 1900. By 1906 the first electric arc furnace in the United States was operating in Syracuse, with the second one installed in 1908 at the Firth-Sterling Steel Company in McKeesport, Pennsylvania. Other small firms using electric arc furnaces to make alloy steels opened in Pennsylvania, particularly southwestern Pennsylvania. The Latrobe Electric Company, founded in 1913 in Latrobe, had three electric arc furnaces by 1918 for making specialty alloy steels. In 1916 the Electric Furnace Reduction Company began producing alloy steel in an electric arc furnace in Washington, Pennsylvania. Larger firms installed electric arc furnaces in Pennsylvania during the 1920s, with the Bethlehem Steel Corporation beginning electric arc production at its Bethlehem plant by 1927. Electric arc furnaces by the

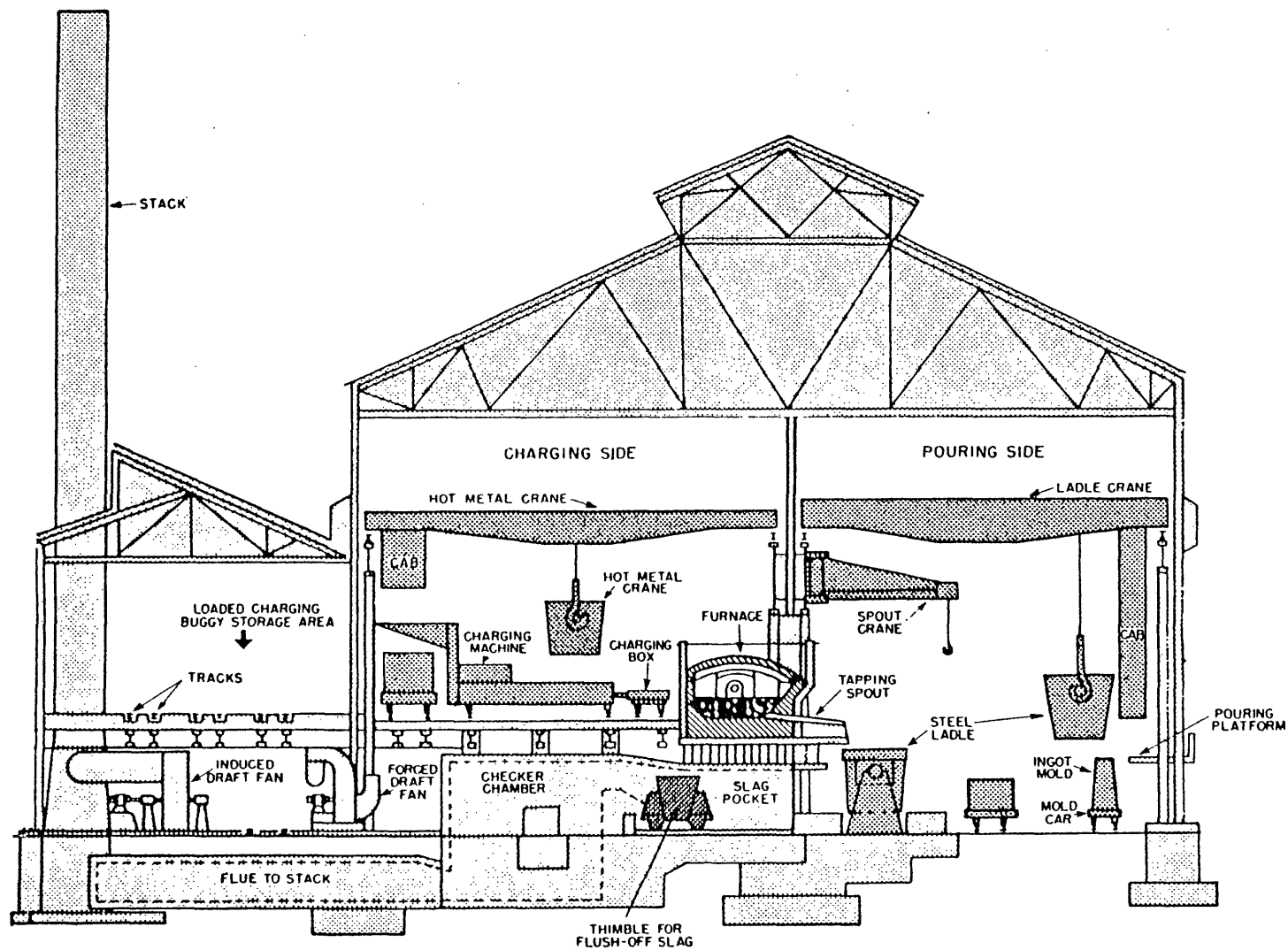

Cross section of an open hearth plant. The open hearth furnace is located in the middle, with charging floor, charging box, charging machine, and overhead travelling crane to the left. Further to the left is the stack and more loading storage space. To the right of the furnace is the pouring pit with overhead travelling crane, ingot mold, and ladles. A checker chamber and slag pocket are shown underneath the furnace. (Source: William T. Hogan, Economic History of the Iron and Steel Industry in the United States (Lexington, MA.: Lexington Books, 1971), 2: 407.)

United States Department of the Interior  
National Park ServiceNational Register of Historic Places  
Continuation Sheet

Iron and Steel Resources of Pennsylvania, 1716-1945

E 94

Section number \_\_\_\_\_ Page \_\_\_\_\_

1930s consisted of a cylindrical vessel with curved top and bottom lined with refractory brick. At the beginning of a heat, the top of the vessel was removed by swinging it to one side, and measured quantities of various types of scrap steel were loaded into the vessel. The top was moved back over the vessel, and two giant electrodes were lowered into the vessel through openings in the top. Electricity then arced between the electrodes, passing through the scrap steel and melting it. The electrodes were withdrawn, and the vessel was tilted to pour the melted steel into a ladle or ingot molds. By World War II, an electric arc furnace could make up to fifty tons of steel in one heat. Electric arc furnaces had the advantage of being flexible, since the electric charge and heat in the furnace could be varied, making it easy to manufacture different types of steels requiring different temperatures. Also, the electric current, unlike coke, did not introduce impurities in the steel. Electric arc furnaces could produce very high quality steel with fewer impurities or structural weaknesses than Bessemer and open hearth furnaces. These advantages in structure and purity were critical in making alloy steels.<sup>20</sup>

Iron blast furnaces also improved in output and efficiency. Steel firms expanded the width of blast furnaces to as much as twenty seven feet, and the daily capacity to 1,400 tons of iron. Two of the largest furnaces erected between 1902 and 1945 were constructed during World War II at the Edgar Thomson Works. Skip hoists and ore bridges also increased in size to supply the growing furnaces. Turbo blowers were developed to force a stronger blast into the furnace. These technological developments meant a shrinking number of furnaces could produce larger quantities of iron. The number of iron furnaces in Pennsylvania declined from 148 in 1900 to seventy-eight in 1939, yet their average annual output increased 151 per cent to 115,407 tons in 1939. The number of iron furnaces in the United States fell from 251 furnaces in 1900 to 223 in 1939, but their average annual output increased even more, 290 per cent, to 141,336 tons in 1939.<sup>21</sup>

The growth of these blast furnaces, the dominance of large steel companies, and evaporating demand for cast iron led to the demise of charcoal and anthracite furnaces, and the rapid decline of merchant iron furnaces fueled with coke. By 1929 the last of the charcoal and anthracite furnaces had gone out of blast in Pennsylvania, and only five charcoal furnaces operated elsewhere in the United States. By 1945 the large blast furnaces integrated into the operations of steel companies also closed many merchant iron furnaces that had been running independently of the steel firms. Merchant iron furnaces had produced iron ingots and other iron products for use by steel mills and other consumers into the early twentieth century. However, merchant iron

**United States Department of the Interior  
National Park Service****National Register of Historic Places  
Continuation Sheet**

Iron and Steel Resources of Pennsylvania, 1716-1945

E 95

Section number \_\_\_\_\_ Page \_\_\_\_\_

companies rarely erected the larger and more efficient blast furnaces being constructed as part of integrated steel plants during the early twentieth century. Merchant iron companies found it difficult to compete with the larger blast furnaces. These firms also found increasingly that steel mills did not need their iron, since integrated steel mills generally supplied themselves with iron. The market for iron outside steel furnaces shrank as fewer products sold in America were made of iron. In 1900 approximately one third of the iron manufactured in the United States was sold for iron products rather than being made into steel; by 1939 only thirteen per cent was sold for use outside the steel mills. Only a handful of merchant iron mills operated by World War II. The Shenango Furnace Company, which began production in 1901, ran two of the last merchant iron blast furnaces in Pennsylvania on Neville Island, immediately downstream in the Ohio River from Pittsburgh.<sup>22</sup>

Integrated steel mills benefitted from another important technological development, the rapid adoption of byproduct coke ovens. Developed in Europe, these tall, narrow ovens much more rapidly transformed coal into coke than beehive ovens did. They also gave a higher coke yield per ton of coal, and utilized poorer grade coal than the coal mined in the Connellsville Coke Region. In addition, they produced valuable byproducts, including tar, sulphate of ammonia, and gas of high heat value. As steel companies adopted these byproduct ovens, they constructed ovens at their integrated plants rather than at the coal beds. The cost of transporting coal to steel mills was higher than shipping coke, but this higher cost was more than offset by the greater efficiency of the byproduct ovens and the value of the byproducts. Byproduct oven gas was piped to various sections of the mill and used as a fuel, replacing coal, gas and other fuels. Other coke oven byproducts were sold to firms making products such as dyes from coal tar, and fertilizer from sulphate of ammonia. In 1895 the Cambria Steel Company was the first American steel firm to build byproduct coke ovens. Other steel plants in Pennsylvania rapidly erected byproduct coke ovens during the early twentieth century. The Pennsylvania Steel Company, for example, erected byproduct ovens in Steelton in 1907, the Bethlehem Steel Corporation built byproduct ovens at its Bethlehem plant in 1912, and the Jones and Laughlin Steel Corporation installed coke ovens at its Pittsburgh plant in 1918-1920. In 1918 the United States Steel Corporation completed the world's largest byproduct coke plant, containing 640 ovens, just north of its Clairton Works near Pittsburgh. This coke plant supplied coke to Pittsburgh area plants of the United States Steel Corporation, and gas through nine miles of pipe to the Edgar Thomson, Homestead, Duquesne and Clairton works. By 1930 byproduct ovens almost totally eclipsed beehive ovens, which made only three per cent of the total coke produced in the United States.<sup>23</sup>

**United States Department of the Interior  
National Park Service****National Register of Historic Places  
Continuation Sheet**

Iron and Steel Resources of Pennsylvania, 1716-1945

E 96

Section number \_\_\_\_\_ Page \_\_\_\_\_

The adoption of byproduct ovens played an important role in shifting steel production west of Pennsylvania. The Commonwealth remained the leading state in production of steel, but its margin over states immediately to the west slipped greatly by World War II. In 1900 Pennsylvania mills manufactured fifty-one per cent of the iron and steel made in the United States; by 1939 they produced only twenty-eight per cent of the steel ingots and rolled steel in the nation. Production grew much more quickly in other states, particularly Ohio and Indiana. Ohio had produced seventeen per cent of all iron and steel in 1900, and by 1939 its proportion of steel ingots and rolled steel grew to twenty-two per cent, keeping it in second place among all states. Indiana became the third largest producer of steel, in large part because of the construction of the United States Steel Corporation's gigantic plant at Gary. Indiana's share of production blossomed from one per cent in 1900 to twelve per cent in 1939. Illinois's rank, however, slightly declined from third in 1900 with ten per cent of total production to fourth with approximately seven per cent in 1939. Production spread westward in part because western Pennsylvania, and especially Pittsburgh, lost much of its advantage as a materials assembly point. The growing adoption of byproduct ovens meant that proximity to the Connellsville Coke Region was less important for steel plants. Since the byproduct ovens could use coal mined outside the Connellsville Coke Region, Kentucky, Virginia and West Virginia rose as sources of coking coal. Steel plants in Ohio, Indiana and Illinois were well placed geographically to take advantage of these newer sources of coking coal. Markets for steel products, especially the most rapidly growing market for sheet steel, also shifted westward.<sup>24</sup>

Although production shifted west, steel companies continued to cooperate with each other in ensuring markets and profits for all. This lack of competition had profound effects on workers and labor-management relations. As David Brody states,

The competitive era ended in 1901, and with it the necessity for the economizing labor policy in its undiluted form. No basic alteration occurred, but the steelworker's situation improved considerably in succeeding years. A leaven of benevolence was introduced, bringing an added measure of stability to the labor system.<sup>25</sup>

Steel companies still tried to cut labor costs, much as they had done during the later nineteenth century, but the pressure to cut labor costs to meet competition was not as severe. In addition, steel executives who espoused cooperation among themselves extended cooperation to labor-management relations. Judge Gary proposed that workers be treated



United States Department of the Interior  
National Park ServiceNational Register of Historic Places  
Continuation Sheet

Iron and Steel Resources of Pennsylvania, 1716-1945

E 97

Section number \_\_\_\_\_ Page \_\_\_\_\_

fairly just as the steel companies did with each other. If fairness "is a good doctrine for us," he told other steel leaders, "it is equally as good for others.... We should have it in mind in dealing with our employees." Treating workers better could also be financially profitable for steel companies. They calculated, for example, that preventing accidents through safety programs was less expensive than paying workmen's claims under state workmen's compensation laws passed in the early twentieth century. Steel company executives also stated that health and safety measures improved employees efficiency. C.L. Woodridge, an official of the Carnegie Company, concluded in 1922 that as improvements in working conditions occurred, "the employees' efficiency actually increased, so that today every modern plant has its Department of Safety, Sanitation and Welfare."<sup>26</sup>

Improving workers' welfare would also placate public opinion, and most importantly, instill worker loyalty. Welfare measures would stave off adverse publicity about the steel industry, which was mounting during the early twentieth century. Private and government organizations investigated working conditions at steel mills in Pennsylvania and other states between 1902 and World War I. For example, the Charity Organization Society of New York conducted a survey of Pittsburgh that detailed the dangers, accidents, long work days, poor wages, and repression steel workers experienced in the mills. Their findings, published in 1909-1911, revealed to a wider public the dangers inherent in the mills. Judge Gary was especially anxious to avoid such publicity which might lead to calls for the prosecution of the United States Steel Corporation under the Sherman Antitrust Act. Judge Gary and other steel executives also believed that improving workers lives would engender workers' loyalty. As C.L. Woodridge explained, employers "found it was easier to get men and hold them if their plants were clean and light, had decent toilet facilities, and were made as safe as possible." Welfare measures would show workers the companies' intent to cooperate with employees, and preclude workers' need to turn to strikes or unions. In seeking to foster labor stability, steel companies joined a larger movement spreading through American industry during the early twentieth century called welfare capitalism. Employers hoped that a broad range of measures instituted as welfare capitalism would kill the organized labor movement with kindness. Those companies that most generously improved workers' welfare were generally the most strongly anti-union in their labor management policies.<sup>27</sup>

The welfare measures undertaken by steel companies during the early twentieth century included safety campaigns, workers compensation, employee housing, and employee representation plans. Worker safety was one of the first concerns addressed by steel firms. Steel mills were a

United States Department of the Interior  
National Park ServiceNational Register of Historic Places  
Continuation Sheet

Iron and Steel Resources of Pennsylvania, 1716-1945

E 98

Section number \_\_\_\_\_ Page \_\_\_\_\_

dangerous workplace, with hundreds of men killed and injured each year in the late nineteenth and early twentieth century. In 1902 115 skilled steel workers were killed in Allegheny County alone. Steelworkers across the Commonwealth suffered serious injuries, particularly burns and dismemberment. For example, at the Phoenix Iron Company in 1908, John Calhoun, age seventy-four, had his left leg amputated after he was struck and run over by a locomotive at the plant. In 1910 at the same mill, Mike Kukas, age forty-five, burned his hands and one leg when molten steel being poured into an ingot mold blew out of the mold and over him. Death or injury meant lost savings and perhaps poverty for the workman's family. The high accident rate in steel mills also attracted much of the attention and publicity that investigators gave to working conditions in the mills.<sup>28</sup>

The United States Steel Corporation led in instituting safety measures in the steel industry. In 1908 the firm created an inspection system that included accident investigations, inspection of machinery and workplaces, and recommendations for safety improvements. The United States Steel Corporation pioneered a wide range of safety devices such as guards on machinery, and safety procedures such as posting signs in several languages warning of danger spots. It also preached safety to employees on bulletin boards, in pay envelopes, and in short lectures to workers. Between 1908 and 1916 the United States Steel Corporation cut serious accidents forty-three per cent. Similar safety programs spread throughout the steel industry by 1914. For instance, the Bethlehem Steel Corporation implemented an inspection system, safeguards and safety procedures, and safety education. With the decline in accidents, steel firms could afford to undertake employee compensation insurance for injured or killed workmen and their families. Such insurance programs also spurred companies to further cut accident rates in order to lower premiums. Steel firms found further incentive to reduce accidents when state governments enacted a wave of compulsory accident insurance beginning in 1911. Pennsylvania enacted such insurance in 1915.<sup>29</sup>

Steel companies took other measures to ensure workers' health and safety. They purified drinking water, added bathrooms, baths and lockers, improved sewage disposal, and built ventilating and heating systems in the plants. Many mills created plant emergency hospitals and restaurants, encouraged workers to form sick benefit clubs, took out life insurance policies for employees, and created pension plans. In addition some firms offered vacant land for gardens. In 1910 the National Tube Company was the first to create a playground, setting aside a plot previously used as a dumping ground in Pittsburgh. Steel companies also commonly employed visiting nurses to teach health and sanitation methods, particularly to immigrants who they sought to

**United States Department of the Interior  
National Park Service****National Register of Historic Places  
Continuation Sheet**

Iron and Steel Resources of Pennsylvania, 1716-1945

E

99

Section number \_\_\_\_\_ Page \_\_\_\_\_

Americanize. Many plants sponsored picnics and sports events and teams. The Bethlehem Steel Corporation, for example, sponsored football teams in Bethlehem and Steelton, and hired a few plant employees primarily for their football talents. Steel companies also organized classes, such as English and citizenship classes for immigrants, again as part of an effort to Americanize them.<sup>30</sup>

Another important welfare measure was constructing housing for workers, particularly during World War I as production and the number of workers grew. Employers did not intend to make large profits from company housing, and often the rents and sale prices they charged undercut private housing in steel mill communities. Steel companies instead sought to reinforce workers' loyalty, and further labor stability and productivity. As Walter J. Riley, an official of the Inland Steel Company in Indiana, Harbor, Indiana stated in 1922, the object of industrial housing was to "Increase the number of home owners, stabilize plant labor conditions, and thereby reduce production costs." Employers preferred to sell homes rather than rent them, and frequently offered low interest loans to encourage workers to buy a stake in the steel community.<sup>31</sup>

Employers constructed houses in steel towns scattered across Pennsylvania. In 1916 the Midvale Steel and Ordnance Company erected in Coatesville one hundred homes for common laborers and their families, and seventy houses for skilled workers. In 1919 the same firm built one hundred homes in Johnstown. Throughout the nation fifty-six of seventy-four steel establishments were helping to house employees in 1911, although often on a small scale. During the late 1910s and early 1920s some steel companies sought to improve the quality of housing they built in order to further instill labor loyalty. Beginning in 1919 the United States Steel Corporation devised standard house designs that would fit the average workman's furniture, make the floorplan convenient and the house easy to care for, yet keep the house as compact as possible to minimize construction costs. By 1922 the Carnegie Company subsidiary of the United States Steel Corporation selected seven model floor plans with four to seven rooms. Its cheapest house was built over a half cellar, with no bathroom, and the dining room and kitchen, or the dining room and living room, were combined as one room. A more expensive design featured a full cellar, separate dining room, living room and kitchen, and a bathroom. The houses were built with as many standard dimensions and construction materials as possible to minimize cost. Some of these homes were erected in Homestead.<sup>32</sup>

A number of steel firms instituted employee representation plans to gain workers' loyalty and prevent them from joining independent unions.

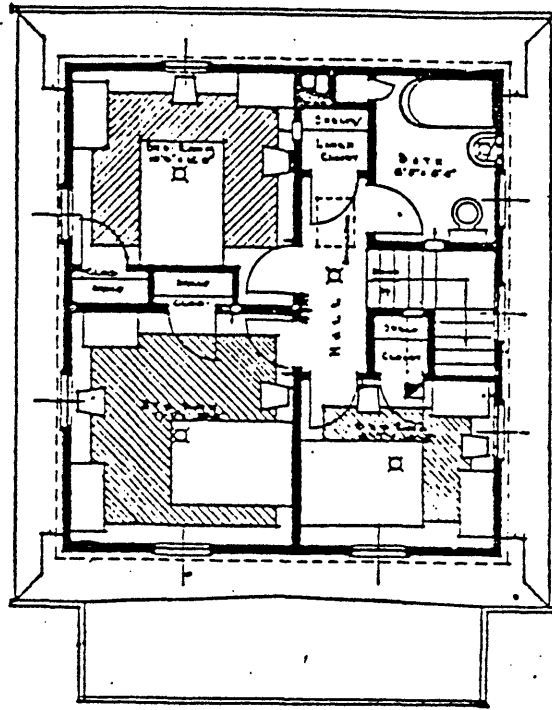

SECOND-FLOOR-PLAN.

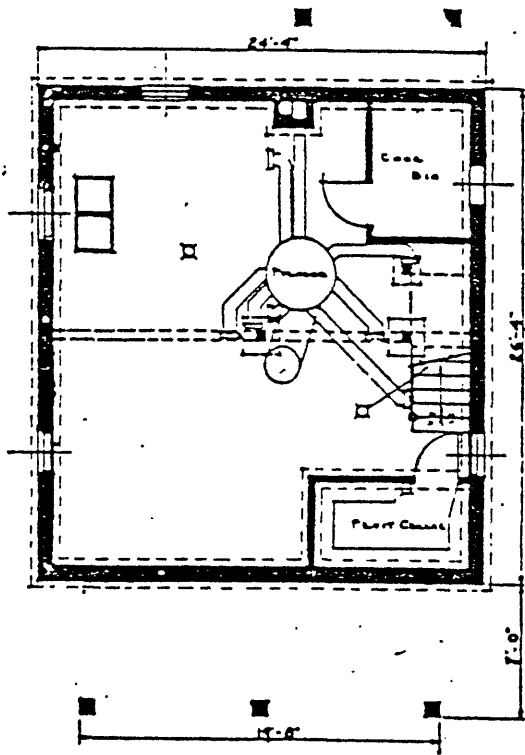

BASEMENT-PLAN.

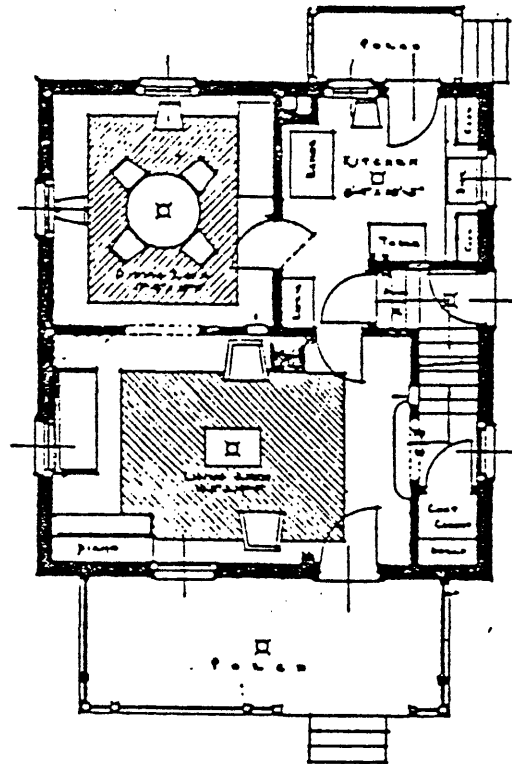

FIRST-FLOOR-PLAN.

Six-room house plan of the Carnegie Company, 1922. (Source: C.L. Woolridge, "Industrial Housing," Yearbook of the American Iron and Steel Institute (1922), p. 96.)

United States Department of the Interior  
National Park Service

## National Register of Historic Places Continuation Sheet

Iron and Steel Resources of Pennsylvania, 1716-1945

E 101

Section number \_\_\_\_\_ Page \_\_\_\_\_

---

The Midvale Steel and Ordnance Company and Lukens Steel Company voluntarily instituted employee representation plans in 1918. The Bethlehem Steel Corporation accepted employee representation at its Bethlehem plant after being ordered to do so by the National War Labor Board in 1918, and then voluntarily spread the system to its other mills. In taking credit for this decision, Charles Schwab reasoned,

the best understanding that can be reached between capital and labor is achieved when the workmen realize that they are as much a part of the business as the stockholders. This can be achieved only by maintaining the closest kind of contact with the worker.... through the sort of representation I have always favored--the organization in which the men choose their own representatives, who in turn deal with the management.

Schwab concluded his argument for employee representation, "we have never had a union in our plants, because there was no necessity for one." The details of employee representation plans varied from firm to firm, but all plans created a system for election of workers' committees that dealt with managers on grievances, and at some plants, engaged in collective bargaining on pay, hours, work rules, and working conditions. At the Bethlehem Steel Corporation, judging from the high percentage of workers voting in employee representative elections, many workers supported this plan. But employee representation plans created what were in effect company unions--collective bargaining agents created and dominated by the employer. The United States Steel Corporation was the major holdout against employee representation. Judge Gary believed that welfare measures alone would preserve labor stability. Instead of employee representation, the United States Steel Corporation offered workers a plan to buy stock in the company.<sup>33</sup>

The steel town was another important source of labor stability after the turn of the century. The steel company held the most economic and political power in most steel communities. With the decline of the Amalgamated Association by the early twentieth century, there was seldom any other local organization that could challenge the dominance of the steel company. Most steel communities were one-industry towns, and even larger cities were dominated by steel, such as Pittsburgh where steel manufacturing constituted one half of local industry. Steel firms could usually count on local businessmen for support, since the well being of the steel plants was critical to local economic prosperity. For example, during a 1910 strike, merchants in South Bethlehem at first supported employees. When Schwab threatened to close the steel plant, the businessmen quickly fell in line with the steel company. Company officials dominated local government, often holding prominent positions

**United States Department of the Interior  
National Park Service****National Register of Historic Places  
Continuation Sheet**

Iron and Steel Resources of Pennsylvania, 1716-1945

E 102

Section number \_\_\_\_\_ Page \_\_\_\_\_

in municipal government. Steel companies sometimes manipulated workers' votes in support of company candidates, telling employees they would be discharged if they voted incorrectly. During labor organizing drives or strikes, municipal officials often supported the steel companies. The burgess of Vandergrift ordered five Amalgamated Association organizers out of town and forbade a Labor Day parade during a 1909 strike. Churches and local service organizations such as the Y.M.C.A. also frequently proved uncritical of steel employers, in part because the steel companies were often their principal source of funding. The United States Steel Corporation, for example, included charitable contributions as a regular part of its annual budget. Some workers recognized the role that churches usually played in mill communities, for as one Pittsburgh area employee said in 1908, "The preachers don't have any influence in securing better conditions for the men and they don't try to have."<sup>34</sup>

Social and economic alignments among workers also tended to divide employees, preventing labor solidarity and promoting labor stability in the mills. By the early twentieth century southern and eastern European immigrants were one of the largest if not the largest group of workers in Pennsylvania plants. For instance, at the Allegheny County mills of the Carnegie Steel Company in 1907, these immigrants represented fifty-six per cent of the work force. Western and northern European immigrants totaled fourteen per cent, native-born white workers twenty-five per cent, and native-born blacks one per cent. The native-born white employees formed a majority of the skilled workers, while eastern and southern European immigrants dominated the unskilled ranks. The native-born white workers and western and northern European immigrants disdained black and eastern and southern European laborers, whom they believed lowered labor standards and displaced them from the mills. Native-born white and northern and western European immigrants increasingly refused to take unskilled jobs, and semiskilled positions were occupied more and more by eastern and southern European immigrants and blacks. This employment trend led to a decline in the proportion of native-born white and German and English employees in the mills by 1910.<sup>35</sup>

United States Department of the Interior  
National Park Service

# National Register of Historic Places Continuation Sheet

Iron and Steel Resources of Pennsylvania, 1716-1945

E 103

Section number \_\_\_\_\_ Page \_\_\_\_\_

Ethnic Composition of Work Force at Allegheny County Plants  
of the Carnegie Steel Company, 1907

	Total Work Force		Skilled Workers		Semi-skilled Workers		Unskilled Workers	
	#	%	#	%	#	%	#	%
Native-Born Whites	5,795	25	2,316	58	1,879	38	1,510	11
Native-Born Blacks	331	1	66	2	76	1	189	1
North & West Euro- pean Immigrants	3,221	14	1,188	30	992	20	1,021	8
South & East Euro- pean Immigrants	13,003	56	359	9	1,946	39	10,698	74
Others	1,007	4	59	1	96	2	922	6.36
Total	23,337	100	3,988	100	4,989	100	14,360	100

Eastern and southern European immigrants and blacks occupied the lower rungs of the social and economic ladder in steel communities. During the first years of the twentieth century many eastern and southern European immigrants continued to seek steady employment so that they could send or bring back wages to their home countries. But by the 1910s immigrant steel workers increasingly regarded the United States as their home, bringing their wives and relatives to America. After 1921 migration back and forth between the United States and Europe was greatly restricted by federal legislation. Immigrants increasingly saw their jobs as careers and sought promotions, which more of them obtained during the 1910s and 1920s as they learned job skills and native-born and northern and western European immigrants left the mills. Eastern and southern European immigrants often became the immediate supervisors of blacks who were at the bottom of the job and social hierarchy. A relatively small number of blacks was employed in the steel plants in the early years of the century. However, steel firms hired thousands of blacks during labor shortages such as occurred in World War I and during the 1920s when foreign immigration declined. Steel companies recruited blacks from the south who wanted to escape low wages, poor living conditions, and social, educational and legal inequalities. By August, 1917 4,000 blacks worked at Carnegie Company mills in the Pittsburgh area, while 4,400 labored in the plants of the Jones and Laughlin Steel Corporation. In 1920 eleven per cent of the steel workers in Pennsylvania were blacks. These employees received better wages in steel mills than what they had gained in the south, but they still often lived in the worst housing in steel towns, and faced the racism of both immigrant and native-born residents. Some steel firms also hired

United States Department of the Interior  
National Park ServiceNational Register of Historic Places  
Continuation Sheet

Iron and Steel Resources of Pennsylvania, 1716-1945

Section number       E       Page       104      

Mexicans for unskilled jobs during labor shortages or as strike breakers. In April and May, 1923 the Bethlehem Steel Corporation brought to Bethlehem nearly a thousand Mexicans recruited in Texas. Steel companies rarely resorted to hiring women, even during labor shortages; very few women worked in steel mills.<sup>37</sup>

Added to these various sources of labor stability was steel companies' steadfast opposition to unions and strikes. Steel firms fought unions and walkouts which they believed challenged their profits and control of the mills. For example, steel executives opposed bargaining collectively with employees over wages, which they believed it was their prerogative to set, and which directly affected their labor costs and profits. Judge Gary saw an even wider conspiracy by unions to gain control. He contended, "The contemplated progress of trade unions, if successful, would be to secure the control of the shops, then of the general management of business, then of capital, and finally of government." Company officials also held that unions engendered unwarranted antagonism between employees and employers. As Charles Schwab argued,

It has always seemed a curious thing to me that people should talk about the 'conflict' between capital and labor. There is no conflict. It is human nature to want money. Capital wants money, so does labor. Where you see men, either as individuals or in groups, wanting more money, that's not conflict. The interests are identical.

Labor organizers were seen as outside agitators fomenting conflict where there was no cause for disagreements. Steel executives also told the public that they were defending democracy in the workplace against union demands for a closed shop. Unions sought to make working in steel mills contingent on union membership; employment in a mill would be closed to men who were not union members. Steel companies supported an open shop, in which men could labor<sup>38</sup> in a plant and freely choose whether they wanted to join a union.

The various sources of labor stability plus steel companies' concerted actions against unionization prevented successful strikes and union organizing drives between 1902 and 1917. The Amalgamated Association, shattered by its failed 1901 walkout against the United States Steel Corporation, mounted only one major strike before 1919, a 1909 turnout sparked by the United States Steel Corporation unilaterally declaring the open shop in its mills and implementing pay reductions. Amalgamated Association members struck unionized mills, particularly plants west of Pennsylvania, for up to a year. The United States Steel



United States Department of the Interior  
National Park ServiceNational Register of Historic Places  
Continuation Sheet

Iron and Steel Resources of Pennsylvania, 1716-1945

E 105

Section number \_\_\_\_\_ Page \_\_\_\_\_

Corporation, however, shifted production from unionized mills to other plants and defeated the strike by August, 1910. This Amalgamated Association failure left no effective labor opposition to management policies. Between 1910 and 1917 firms simply notified workers of the conditions of employment with little fear of protests. For example, in 1912 and 1913 the American Federation of Labor attempted an organizing campaign in steel mills which resulted in several successful strikes for higher wages occurring at mills in Braddock and Rankin, Pennsylvania. Except for these few victories, however, the campaign accomplished little, and the American Federation of Labor abandoned its organizing drive.<sup>39</sup>

World War I greatly altered labor-management relations, quashing temporarily sources of labor stability. Economic conditions including a labor shortage helped lead to labor unrest. With war orders growing, steel companies began seeking more employees, while the flow of immigrants into the United States and steel mills slowed greatly. Steelworkers, realizing that their labor was in greater demand, began to agitate for higher pay. In late April 1916, Westinghouse strikers from East Pittsburgh marched from plant to plant encouraging steelworkers to join them for pay raises. At the Edgar Thomson Works guards opened fire on marchers, killing two and inciting mob violence in Pittsburgh area steel towns. The arrival of troops quelled the protest, and no further significant strikes occurred until 1919. Steel firms raised wages to prevent protests, and recruited blacks to help alleviate the labor shortage. They also strengthened welfare measures for eastern and southern immigrant workers in order to keep them working in the mills.<sup>40</sup>

Patriotic mobilization drives and President Wilson's support for organized labor helped create further labor unrest in 1919. Employees were told at patriotic rallies that steel and steelworkers were essential to the war effort. Through rallies, parades and posters, employers urged workers to fulfill their patriotic duty and increase production. At a rally on July 2, 1918 the superintendent of the Homestead plant told cheering workers that 179 production records had fallen there since the start of the war. Employers also encouraged workers to contribute to bond drives. Plants of the Bethlehem Steel Corporation were organized into competing sections for war bonds. Employees responded by meeting or exceeding their bond quotas at the vast majority of steel mills. As employees were told they were increasingly important, their sense of patriotic sacrifice was increased by harsher working and living conditions. Seven-day work weeks had largely ended by 1915, but steel firms reinstated them by 1917 in order to meet war production demands. Steel firms advanced wages during the war, but rapid increases in food and fuel prices and rents consumed

United States Department of the Interior  
National Park ServiceNational Register of Historic Places  
Continuation Sheet

Iron and Steel Resources of Pennsylvania, 1716-1945

E 106

Section number \_\_\_\_\_ Page \_\_\_\_\_

much of the raises. Housing conditions also deteriorated as company and private house builders struggled to keep up with expanding work forces. President Wilson furthered recognition of the vital role workers played in the war effort. Eager to gain labor cooperation in war production, he accepted the American Federation of Labor's call that organized labor be recognized as the spokesman for workers, and that unions be represented in federal government war agencies. In April, 1918 he formed the National War Labor Board in order to prevent strikes that might retard production. In exchange for a pledge of no strikes during the war, the War Labor Board offered unions the right to organize and bargain collectively through representatives chosen by the workers without interference from employers. As previously noted, the War Labor Board enforced this offer against the Bethlehem Steel Corporation at its Bethlehem plant. Organized labor had found a powerful advocate in the federal government.<sup>41</sup>

Efforts to mobilize workers against management policies culminated with a major organizing drive and large-scale steel strike. In 1918 the American Federation of Labor began a campaign to unionize steelworkers along industrial and craft lines. Union locals at each steel plant would be formed as part of national craft unions, but the locals would also cooperate with each other in workers' industrial councils. The American Federation of Labor trumpeted the unionization of steelworkers by appropriating the war goal of fighting for democracy; it called for economic democracy by forming unions that would give workers a voice against powerful steel companies. At first steel executives were hesitant to fight the union campaign for fear that the War Labor Board would intervene in support of wide spread unionization, as it had begun to do with the Bethlehem Steel Corporation. But when the war ended on November 11, 1918, the War Labor Board lost its coercive powers to support unionization. Steel firms mounted an offensive against union organization, including firing union members. Despite such tactics, by the spring of 1919 100,000 men had become members of unions outside the Pittsburgh area, and the American Federation of Labor had begun to make inroads in the Pittsburgh district. The unions gained more members as plants cut back production in 1919, throwing thousands of employees out of work. At five Bethlehem plants, for example, the number of workers shrank from 28,000 at the end of the war to 11,000 in March, 1919. The unions also won support when steel firms refused to shorten the work week or the twelve hour work day. Armed with growing labor support, the unions demanded of Judge Gary the right of collective bargaining, an eight hour day, six day work week, and wage increases, among other demands. Judge Gary, speaking for the steel industry, refused to negotiate.<sup>42</sup> Steelworkers went on strike in nine states on September 21, 1919.

United States Department of the Interior  
National Park ServiceNational Register of Historic Places  
Continuation Sheet

Iron and Steel Resources of Pennsylvania, 1716-1945

E 107

Section number \_\_\_\_\_ Page \_\_\_\_\_

The "Great Strike" of 1919, as it was called, eventually ended in failure for the strikers. At first the turnout was very effective. By the end of September approximately 350,000 employees had walked out, shutting down much of the industry completely, with the Johnstown mill closed and about three quarters of the mills in the Pittsburgh area affected. Yet the steel companies soon succeeded in portraying the strikers as radical, anti-American Bolsheviks. A prominent leader of the strike, William Z. Foster, had been a member of the radical International Workers of the World union and praised the Bolshevik revolution begun in Russia in 1917. The steel firms tarred the strikers with association with Foster at a time when much of the nation was gripped by the "red scare," an almost hysterical fear of radicals, particularly foreign radicals. The fact that many of the strikers were immigrants only furthered public perception of the strike as un-American. President Wilson's administration, which had supported organized labor during the war, now refused to intervene on behalf of the strikers. The unions within the American Federation of Labor that had sponsored the organizing campaign began to withdraw their support, and workers started returning to the mills. The steel companies also brought in thousands of strike breakers, particularly blacks, employed labor spies, and had local and state police smash picket lines and break up strike meetings. Faced with shrinking labor support and growing company opposition, strike leaders called off the walkout in January, 1920.<sup>43</sup>

The end of strike marked a return to labor quiescence during the 1920s, supported by many of the same sources of stability dominating labor-management relations before World War I. Steel companies intensified welfare measures undertaken before the war, and more widely adopted employee representation plans. In 1920, shortly after the strike ended, steel firms granted a pay increase. Pressed by investigations into working conditions and by President Harding, the steel industry shortened the work day from twelve to ten hours. Employers also recruited blacks and Mexicans as European immigration declined sharply. Organized labor did little to enlist steelworkers' support during the decade. A modest organizing drive by the American Federation of Labor in Chicago, Cleveland and Bethlehem plants failed miserably in 1923. The Amalgamated Association lost members, particularly as hot strip mills replaced its skilled hand sheet mill members. By 1929 the Amalgamated Association had only 8,605 members, little more than it had in 1914. Organized labor stood largely powerless against the large steel corporations during the 1920s.<sup>44</sup>

The 1930s and early 1940s witnessed a dramatic reversal in fortunes for organized labor, culminating in the formation of a truly effective

**United States Department of the Interior  
National Park Service****National Register of Historic Places  
Continuation Sheet**

Iron and Steel Resources of Pennsylvania, 1716-1945

E

108

Section number \_\_\_\_\_ Page \_\_\_\_\_

national steelworkers' union, the United Steelworkers of America. This reversal occurred largely because of federal government support for organized labor, the organizing resources and commitment of the United Mine Workers and the newly formed Congress of Industrial Organization, and rising employment in the steel industry during the mid- to late 1930s. President Roosevelt and Congress firmly supported union organization, more so than any previous President or Congress had done. President Roosevelt in particular was concerned with the rights and welfare of industrial workers, and wanted to enable organized labor to deal on equal terms with employers over workers' welfare. In 1933 the President and Congress approved the National Industrial Recovery Act in order to increase employment, ensure reasonable profits for industry without unfair competition and ruinous overproduction, and raise workers wages in part by spreading work over shorter hours. Section 7(a) of this act required that workers have the right to organize and bargain collectively through representatives chosen by them without interference from employers. Section 7(a) stipulated that no employee would be required to join an employee representation plan or prevented from joining any labor organization. Employers must comply also with maximum hours, minimum wages, and other conditions of employment approved by the President. Although the Supreme Court declared the National Industrial Recovery Act unconstitutional in 1935, the Wagner Act passed the same year continued and strengthened the provisions of Section 7(a). The Wagner Act effectively ended past barriers to union organization, providing unions considerable protection from interference by employers.

As New Deal legislation spurred union organization, John L. Lewis, president of the United Mine Workers, and the newly formed Congress of Industrial Organization moved to unionize the steel industry. In 1935 Lewis led a faction within the American Federation of Labor to unionize the great mass of unskilled workers previously ignored by the skilled trade unions. William Green, president of the American Federation of Labor, cautiously continued to advocate organization according to craft union lines. After a bitter personal conflict between the two labor leaders, Lewis in 1935 led advocates of industrial unions in forming the Committee for Industrial Organization, which in 1938 became the Congress of Industrial Organization. The split between Lewis and Green was completed when Green suspended from American Federation of Labor membership ten unions, including the United Mine Workers, that had joined the Committee for Industrial Organization. The Committee for Industrial Organization then embarked on an ambitious organizing drive of workers in various industries. Its most important drive was among the nation's steelworkers. In June, 1936 it established the Steel Workers' Organizing Committee, led by Philip Murray, formerly vice president of

**United States Department of the Interior  
National Park Service****National Register of Historic Places  
Continuation Sheet**

Iron and Steel Resources of Pennsylvania, 1716-1945

E 109

Section number \_\_\_\_\_ Page \_\_\_\_\_

the United Mine Workers. The timing of the organizing drive was opportune for more potential members were flowing into steel mills. Between June, 1936 and May, 1937, steel companies expanded production from seventy-one per cent of capacity to eighty-nine per cent, and sought more workers, swelling employment by 50,000 workers.<sup>46</sup>

The Steel Workers' Organizing Committee created the most effective unionization drive in the industry's history, and within a year negotiated a major contract with the United States Steel Corporation. The Steel Workers' Organizing Committee took over the small Amalgamated Association and sent approximately four hundred organizers to steel towns in Pennsylvania and other states, holding mass meetings, canvassing workers' homes, and handing out union literature. Workers created mill organizing committees, which encouraged employees to join the union and kept members names secret until the union became strong enough to offset employer resistance. Organizers also tried to push representatives in employee representation plans to seek more aggressively the union's demands, including higher wages and a forty hour work week. When representatives did not move aggressively enough, employees at some mills protested for the abolition of the representation plan. The steel companies' efforts to lambast the union for seeking a closed shop which was undemocratic only served to mobilize more workers in support of the organization drive. By March, 1937 the Steel Workers' Organizing Committee had signed 150,000 steelworkers and established lodges throughout the industry. The union appeared strong enough to demand recognition and a contract, and militant enough to resort to a national strike to achieve its demands. Myron C. Taylor, head of the United States Steel Corporation, wanted to avoid a strike, particularly since demand for steel was increasing. He had also witnessed the beginning of a massive strike by the United Automobile Workers against General Motors on December 30, 1936, and the refusal of state and federal officials to evict strikers who simply sat down in and closed automobile plants. On March 2, 1937 the United States Steel Corporation signed a contract with the Steel Workers' Organizing Committee that recognized the union as bargaining agent and granted a ten per cent wage increase, an eight hour day, and a forty hour week. This victory, and the contract won by the United Automobile Workers with General Motors, marked a turning point in American unionization efforts. Both skilled and unskilled workers employed by the largest companies in two of America's largest industries had finally gained union recognition.<sup>47</sup>

The Steel Workers' Organizing Committee had negotiated successfully with "big steel," the United States Steel Corporation, but met much stiffer resistance from the "little steel" companies composed of the

United States Department of the Interior  
National Park ServiceNational Register of Historic Places  
Continuation Sheet

Iron and Steel Resources of Pennsylvania, 1716-1945

E 110

Section number \_\_\_\_\_ Page \_\_\_\_\_

Bethlehem Steel Corporation, the Republic Steel Corporation, and four other firms. The "little steel" companies steadfastly refused to negotiate a contract, which led the Steel Workers' Organizing Committee to call a strike in May, 1937. Some 75,000 workers walked out, but the steel companies successfully mobilized police and militia against the strikers. Violent clashes between police and strikers resulted in a number of steel communities. On May 30, Chicago police seeking to disperse a holiday picnic crowd of striking workers and their families near the South Chicago works of the Republic Steel Corporation opened fire on the crowd, killing ten and injuring over one hundred. Twenty-two policemen were wounded in the resulting street violence. The strike ended in defeat for the Steel Workers' Organizing Committee. The economic downturn in 1938 with resulting decline in steel production and employment retarded organizing efforts in the "little steel" companies. But rising production and employment by 1940 enabled the union to recruit new members. Court decisions in 1941 also removed impediments to union organization, dictating that the Bethlehem Steel Corporation abandon its employee representation plan and companies not avoid union recognition by simply refusing to sign a written contract. And Henry Ford's decision to enter into a United Automobile Workers contract in 1941 strengthened the steel union's efforts. The Steel Workers' Organizing Committee triumphed first with the biggest of the "little steel" companies, forcing successful elections of its representatives at Bethlehem Steel Corporation plants. After it became clear that a majority of workers at the other "little steel" companies had joined the union, these firms agreed to contracts with the Steel Workers' Organizing Committee in 1942.<sup>48</sup>

The Steel Workers' Organizing Committee accomplished what no other union had achieved, the unionization of the American steel industry. By mid-1942 it had negotiated contracts with the United States Steel Corporation, the six "little steel" firms, as well as smaller steel companies. It also won recognition as the sole bargaining agent in steel plants. At its May 19, 1942 union convention, the organization changed its name to the United Steelworkers of America, ending the organizing period under the Steel Workers' Organizing Committee. With the support of New Deal legislation, the United Steelworkers of America became a major force checking the power of the steel corporations in labor-management relations.<sup>49</sup>

The small group of giant companies that dominated the steel industry in Pennsylvania and the nation faced an important new power in 1945, organized labor. Steel firms had also adjusted to changing markets for their products, particularly the demand for sheet steel. They also had weathered the economic challenges posed by the Great Depression.

**United States Department of the Interior  
National Park Service**

**National Register of Historic Places  
Continuation Sheet**

Iron and Steel Resources of Pennsylvania, 1716-1945

E

111

Section number \_\_\_\_\_ Page \_\_\_\_\_

---

After 1945 both the steel corporations and the United Steelworkers of America would have to confront challenges from another source. Steel mills in Pennsylvania and much of the rest of the nation would falter, and many would collapse during the 1970s and 1980s as foreign competition undermined the American steel industry.

United States Department of the Interior  
National Park ServiceNational Register of Historic Places  
Continuation Sheet

Iron and Steel Resources of Pennsylvania, 1716-1945

E 112

Section number \_\_\_\_\_ Page \_\_\_\_\_

## ENDNOTES

## Preface

<sup>1</sup>Paul E. Paskoff, Industrial Evolution: Organization, Structure, and Growth of the Pennsylvania Iron Industry, 1750-1860 (Baltimore: The Johns Hopkins University Press, 1983); Peter Temin, Iron and Steel in Nineteenth Century America: An Economic Inquiry (Cambridge: MIT Press, 1964); David Brody, Steelworkers in America: The Nonunion Era (New York: Russell and Russell, 1960); William T. Hogan, Economic History of the Iron and Steel Industry in the United States (Lexington, MA.: Lexington Books, 1971), Vols. 1-5.

Ancient Technology, A Proper Time and Place, and Early Industrial Leadership, 1716-1783

<sup>1</sup>Arthur C. Bining, Pennsylvania's Iron and Steel Industry, Pennsylvania History Studies, no. 5 (Gettysburg: The Pennsylvania Historical Association, 1954), p. 2; Arthur C. Bining, Pennsylvania Iron Manufacture in the Eighteenth Century, 2nd ed. (Harrisburg: Pennsylvania Historical and Museum Commission, 1987), pp. 171-173; James A. Mulholland, A History of Metals in Colonial America (University, AL.: The University of Alabama Press, 1981), pp. xii, 66-67, 72-73, 144.

<sup>2</sup>Bining, Pennsylvania Iron, pp. 55, 64-65; Leslie Aitchison, A History of Metals (London: MacDonal and Evans, 1960), vol. 1, pp. 199-205, 335-342; Percy Knauth, The Metalsmiths, The Emergence of Man Series (New York: Time-Life Books, 1974), pp. 83-84.

<sup>3</sup>Aitchison, History of Metals, vol. 2, pp. 340-343; Bining, Pennsylvania Iron, pp. 65-68; See also the contemporary descriptions and illustrations in Georgius Agricola, De Re Metallica, trans. Herbert Clark Hoover and Lou Henry Hoover (London: The Mining Magazine, 1912; reprint ed., New York: Dover Publications, Inc., 1950), pp. 420-426.

<sup>4</sup>Aitchison, History of Metals, vol. 2, pp. 343-344; Bining, Pennsylvania Iron, pp. 72-73; W. K. V. Gale, Iron and Steel, Industrial Archaeology Series, L. T. C. Rolt, gen. ed. (London: Longmans, Greens and Co. Ltd., 1969), pp. 18-22.



United States Department of the Interior  
National Park ServiceNational Register of Historic Places  
Continuation Sheet

Iron and Steel Resources of Pennsylvania, 1716-1945

E 113

Section number \_\_\_\_\_ Page \_\_\_\_\_

<sup>5</sup>Aitchison, History of Metals, vol. 2, pp. 346-348, 394, 397-401, 405-408, 438; Bining, Pennsylvania Iron, p. 77.

<sup>6</sup>Bining, Pennsylvania Iron, pp. 14-15, 55-57.

<sup>7</sup>Arthur C. Bining, "Early Ironmasters of Pennsylvania," Pennsylvania History, vol. 18, no. 2 (April 1951); (reprint, Harrisburg: Pennsylvania Historical and Museum Commission, 1951), pp. 3-5; Mulholland, Metals in Colonial America, pp. 23-24, 34-35, 59-62, 72-73.

<sup>8</sup>Mulholland, Metals in Colonial America, pp. 61-73; Arthur C. Bining, British Regulation of the Colonial Iron Industry (Philadelphia: University of Pennsylvania Press, 1933), pp. 13-14; Klein and Hoogenboom, History of Pennsylvania, p. 45.

<sup>9</sup>Linda McCurdy, The Potts Family Iron Industry in the Schuylkill Valley (Ph.D. dissertation, The Pennsylvania State University, 1974; pub. Pottstown, Pa.: Pottstown Historical Society, 1975), pp. 29-33; Mulholland, Metals in Colonial America, p. 73.

<sup>10</sup>Bining, British Regulation, pp. 24-30, 134; Bining, Pennsylvania Iron, pp. 20-21, 160-162, 171-173; Mulholland, Metals in Colonial America, pp. 71-73; McCurdy, Potts Family, pp. 12.

<sup>11</sup>Mulholland, Metals in Colonial America, pp. 71-72; Bining, Pennsylvania Iron, pp. 68-69, 96-112; Paskoff, Industrial Evolution, pp. 10-11, 14.

<sup>12</sup>Paskoff, Industrial Evolution, pp. 2-3; Bining, Pennsylvania Iron, pp. 151-153.

<sup>13</sup>Paskoff, Industrial Evolution, pp. 3-6, 15, 25-26; Bining, Pennsylvania Iron, pp. 120, 126, 153-154.

<sup>14</sup>Bining, Pennsylvania Iron, pp. 117-118; McCurdy, Potts Family, pp. 39, 41, 62-63, 199-203.

<sup>15</sup>Jan Margut Habecker, "A Dynasty Tumbles," Pennsylvania Heritage, vol. 13, no. 1 (Winter 1987): 11; Bining, Pennsylvania Iron, pp. 118-119.

<sup>16</sup>Bining, Pennsylvania Iron, pp. 118-120, 127-131.

United States Department of the Interior  
National Park ServiceNational Register of Historic Places  
Continuation Sheet

Iron and Steel Resources of Pennsylvania, 1716-1945

E

114

Section number \_\_\_\_\_ Page \_\_\_\_\_

<sup>17</sup>Mulholland, Metals in Colonial America, pp. xii, 99-113; Bining, British Regulation, pp. 2-3, 114-116.

<sup>18</sup>Mulholland, Metals in Colonial America, pp. xii, 123-125, 127-134, 141-142; Joseph E. Walker, Hopewell Village; A Social and Economic History of an Iron-Making Community (Philadelphia: University of Pennsylvania Press, 1966), pp. 25-26; Bining, Pennsylvania Iron, pp. 122-126, 162-164; McCurdy, Potts Family, p. 206; Paskoff, Industrial Evolution, pp. 69-71; Bining, British Regulation, pp. 99-101, 102-103, 111-112.

Adjustment, Migration and Progress, 1784-1830

<sup>1</sup>Mulholland, Metals in Colonial America, pp. 147, 156; Bining, Iron and Steel, p. 7; Bining, Pennsylvania Iron, pp. 50-54; Peter Temin, Iron and Steel in Nineteenth Century America, An Economic Inquiry (Cambridge, Mass.: The M.I.T. Press, 1964), pp. 1-2; Louis C. Hunter, "Influence of the Market upon Technique in the Iron Industry in Western Pennsylvania up to 1860," Journal of Economic and Business History, vol. 1 (1928-1929; reprint, New York: Kraus Reprint Corporation, 1964): 245-247; Richard N. Current, T. Harry Williams and Frank Freidel, American History, A Survey, 4th edition, vol. 1: To 1877 (New York: Alfred A. Knopf, 1975), p. 235; Convention of Iron Masters, Documents Relating to the Manufacture of Iron, Published on Behalf of the Convention of Iron Masters which Met in Philadelphia on the 20th of December, 1849 (Philadelphia, 1850), pp.....

<sup>2</sup>Mulholland, Metals in Colonial America, pp. 145-147; McCurdy, Potts Family, pp. 166-170; Walker, Hopewell Village, pp. 29-30.

<sup>3</sup>Mulholland, Metals in Colonial America, pp. xiii, 144-147; McCurdy, Potts Family, pp. 168-170.

<sup>4</sup>Bining, Pennsylvania Iron, pp. 145-146; Mulholland, Metals in Colonial America, pp. 152-155; Paskoff, Industrial Evolution, pp. 75-76; Bining, Iron and Steel, pp. 7-9; McCurdy, Potts Family, 171-176.

<sup>5</sup>Mulholland, Metals in Colonial America, p. 156; Paskoff, Industrial Evolution, pp. 72-74, 133; Arthur C. Bining, "The Rise of Iron Manufacture in Western Pennsylvania," The Western Pennsylvania Historical Magazine, vol. 16, no. 4 (November 1933): 240-241.

United States Department of the Interior  
National Park Service

National Register of Historic Places  
Continuation Sheet

Iron and Steel Resources of Pennsylvania, 1716-1945

E 115

Section number \_\_\_\_\_ Page \_\_\_\_\_

<sup>6</sup>Bining, Pennsylvania Iron, pp. 50-54, 173-176; Bining, Iron and Steel, pp. 7-8; Deborah Suciú, "Historic Industrial Resources of Huntingdon County," National Register Nomination, Pennsylvania Historical and Museum Commission, 1989, pp. 6-7, 10-11; Sylvester K. Stevens, "Centre Furnace, A Chapter in the History of Juniata Iron" (master's thesis, The Pennsylvania State College, 1927), pp. 6-11.

<sup>7</sup>Bining, Pennsylvania Iron, pp. 121, 154, 174-176; Bining, "Iron in Western Pennsylvania," pp. 237; Myron B. Sharp and William H. Thomas, A Guide to the Old Stone Blast Furnaces in Western Pennsylvania (Pittsburgh: The Historical Society of Western Pennsylvania, 1966), pp. 43-44, 52.

<sup>8</sup>Bining, Pennsylvania Iron, pp. 174-176; Bining, "Iron in Western Pennsylvania," pp. 237-243; Myron B. Sharp and William H. Thomas, A Guide to the Old Stone Blast Furnaces in Western Pennsylvania (Pittsburgh: The Historical Society of Western Pennsylvania, 1966), pp. 6, 53-54, 78-85; Hunter, "Influence of the Market," p. 247; Current, Williams and Freidel, American History, p. 234.

<sup>9</sup>Bining, Pennsylvania Iron, pp. 71-72; Paskoff, Industrial Evolution, p. 91.

<sup>10</sup>Stevens, "Centre Furnace," pp. 14.

<sup>11</sup>Bining, Pennsylvania Iron, pp. 157-158.

<sup>12</sup>See Hunter, "Influence of the Market," especially pp. 242-247, 252, 264-266, 269, 271, 281; Bining, "Iron in Western Pennsylvania," pp. 245-247.

<sup>13</sup>Alfred D. Chandler, Jr, "Anthracite Coal and the Beginnings of the Industrial Revolution in the United States," Business History Review, vol. 46, no. 2 (Summer 1972): 151-154; W. Ross Yates, "Discovery of the Process for Making Anthracite Iron," The Pennsylvania Magazine of History and Biography, vol. 98, no. 2 (April 1974): 208-211.

Mineral Fuel, Integration, and Soaring Production, 1831-1866

<sup>1</sup>Temin, Iron and Steel, pp. 2-3, 38, 59, 77, 85, 264-266, 280.

United States Department of the Interior  
National Park Service

**National Register of Historic Places  
Continuation Sheet**

Iron and Steel Resources of Pennsylvania, 1716-1945

E 116

Section number \_\_\_\_\_ Page \_\_\_\_\_

---

<sup>2</sup>Temin, Iron and Steel, pp. 24, 109-113; William T. Hogan, Economic History of the Iron and Steel Industry in the United States, vol. 1, parts 1 and 2 (Lexington, Mass.: D.C. Heath and Co., 1971), pp. 85-86.

<sup>3</sup>Temin, Iron and Steel, pp. 35-37.

<sup>4</sup>Temin, Iron and Steel, pp. 38-42.

<sup>5</sup>Temin, Iron and Steel, pp. 44-47.

<sup>6</sup>Temin, Iron and Steel, p. 47.

<sup>7</sup>Temin, Iron and Steel, pp. 47-48.

<sup>8</sup>Temin, Iron and Steel, pp. 48-49; James M. Swank, History of the Manufacture of Iron in All Ages, reprint, American Classics of History and Social Science, Series 6 (New York: Burt Franklin, 1968), pp. 433-435.

<sup>9</sup>Temin, Iron and Steel, pp. 58-59.

<sup>10</sup>Temin, Iron and Steel, pp. 58-59.

<sup>11</sup>Temin, Iron and Steel, pp. 60-61, 74-76.

<sup>12</sup>Chandler, "Anthracite Coal," p.164.

<sup>13</sup>Chandler, "Anthracite Coal," pp. 151-154, 162; Yates, "Anthracite Iron," pp. 207-208, 210-214, 217-221; Temin, Iron and Steel, pp. 61-62.

<sup>14</sup>Chandler, "Anthracite Coal," pp. 162-163; June Evans, "Industrial Archaeology Sites in the Chickies Rock Park Floodplain," unpublished site tour booklet, April 1991, pp. 1-9, 11-14, 14.

<sup>15</sup>Temin, Iron and Steel, pp. 81-82, 264-266, 280.

<sup>16</sup>Temin, Iron and Steel, pp. 85-90.

<sup>17</sup>Temin, Iron and Steel, pp. 51-57, Hunter, "Influence of the Market," pp. 247, 252-253, 281.

<sup>18</sup>Temin, Iron and Steel, pp. 70-73; Hunter, "Influence of the Market," pp. 258-260.

<sup>19</sup>Temin, Iron and Steel, pp. 73-80, 266.

United States Department of the Interior  
National Park ServiceNational Register of Historic Places  
Continuation Sheet

Iron and Steel Resources of Pennsylvania, 1716-1945

E 117

Section number \_\_\_\_\_ Page \_\_\_\_\_

<sup>20</sup>Temin, Iron and Steel, pp. 90-92, 107-109.

<sup>21</sup>Temin, Iron and Steel, pp. 99-101.

<sup>22</sup>Temin, Iron and Steel, pp. 103-110, 117, 266; Hogan, Iron and Steel, pp. 38-40.

<sup>23</sup>Paskoff, Industrial Evolution, pp. 109, 112, 133-135; Temin, Iron and Steel, pp. 109-113.

<sup>24</sup>Temin, Iron and Steel, pp. 130-131, 266; Paskoff, Industrial Evolution, pp. 71.

## The Rise of Big Steel, 1867-1901

<sup>1</sup>United States Census Office, Twelfth Census of the United States Taken in the Year 1900: Manufactures (Washington, D.C.: Government Printing Office, 1902) 11: part 4, p. 8; Peter Temin, Iron and Steel in Nineteenth Century America: An Economic Inquiry (Cambridge: MIT Press, 1964), pp. 2-3, 208-211; David Brody, Steelworkers in America: The Nonunion Era (New York: Russell and Russell, 1970 reissue), p. 9.

<sup>2</sup>Temin, Iron and Steel, p. 4, 125, 131; Diane Kallmann, "Steel on the Susquehanna," Pennsylvania Heritage (Summer, 1990), pp. 33-34.

<sup>3</sup>Two other firms opened Bessemer steel plants for rail production in Pennsylvania before 1890 but quickly failed. The Freedom Iron Company added a Bessemer works that began production in 1868, but the firm failed and most of the works were moved to Joliet, Illinois. The Pittsburgh Steel Company erected a rail plant by 1881, but it too failed. Andrew Carnegie bought the mill in 1883 and converted it to manufacturing structural shapes. See James M. Swank, History of the Manufacture of Iron in All Ages (New York: Burt Franklin, 1892), pp. 411-412; Temin, Iron and Steel, pp. 179-183, 221-224, 282.

<sup>4</sup>Temin, Iron and Steel, pp. 109-110, 225-226, 279; William T. Hogan, Economic History of the Iron and Steel Industry in the United States (Lexington, Mass.: Lexington Books, 1971) 1: pp. 47, 243-245; Kenneth Warren, The American Steel Industry, 1850-1970: A Geographical Interpretation (Oxford: Clarendon Press, 1973), pp. 176-177.

<sup>5</sup>Temin, Iron and Steel, pp. 226-228, 279; Hogan, Economic History, 1: pp. 49-50, 186-188, 191-192, 275-279.

United States Department of the Interior  
National Park Service

**National Register of Historic Places  
Continuation Sheet**

Iron and Steel Resources of Pennsylvania, 1716-1945

E 118

Section number \_\_\_\_\_ Page \_\_\_\_\_

---

<sup>6</sup>Temin quoted in Iron and Steel, p. 228. See also, Thomas Jay Misa, "Science, Technology and Industrial Structure: Steelmakers in America, 1870-1925" (Ph.D. Dissertation, University of Pennsylvania, 1987), pp. 65-81.

<sup>7</sup>Joseph Frazier Wall, Andrew Carnegie (New York: Oxford University Press, 1970), pp. 342, 505.

<sup>8</sup>Eugene G. Grace, Charles M. Schwab (n.p., 1947), p. 9.

<sup>9</sup>Sidney Whipple, "Notes on Mr. C.M. Schwab's Life," p. 39, Papers of the Bethlehem Steel Corporation, Acc. 1699, Hagley Library.

<sup>10</sup>Brody, Steelworkers, pp. 14-17; Temin, Iron and Steel, pp. 133-140.

<sup>11</sup>The dispute between the Wyandotte and Troy groups over who had first produced steel in the United States on an experimental basis, and thus who had legal rights to steel-making patents, has never been conclusively settled. Most historians credit the Troy group rather than William Kelly of the Wyandotte group with first experimental success. See James M. Swank, History of Iron, pp. 409-410 for an earlier account of this dispute and the adoption of Bessemer technology. See Temin, Iron and Steel, pp. 125-132 for a more recent and balanced account.

<sup>12</sup>Temin, Iron and Steel, pp. 132-135, 284-285; Output of Cambria Iron and Steel Company, History of Predecessors, Papers of the Bethlehem Steel Corporation, Acc. 1699, Hagley Museum; United States Census Office, Twelfth Census: Manufactures, 11: Part 4, p. 67.

<sup>13</sup>Temin, Iron and Steel, p. 156.

<sup>14</sup>Hogan, Economic History, 1: pp. 27-30.

<sup>15</sup>Temin, Iron and Steel, p. 163; Hogan, Economic History, 1: pp. 214-217; United States Census Office, Twelfth Census: Manufactures, 11: Part 4, pp. 37, 55, 67; Joel Sabadasz, National Historic Landmark nomination for Duquesne blast furnace number 1, Carrie Furnaces, and Edgar Thomson Furnaces, draft manuscript, 1990, section 8.

<sup>16</sup>Temin, Iron and Steel, pp. 138-145; Hogan, Economic History, 1: pp. 222-223.

<sup>17</sup>Temin, Iron and Steel, pp. 146-150; United States Census Office, Twelfth Census: Manufactures, 11: Part 4, pp. 67-69.

United States Department of the Interior  
National Park ServiceNational Register of Historic Places  
Continuation Sheet

Iron and Steel Resources of Pennsylvania, 1716-1945

E 119

Section number \_\_\_\_\_ Page \_\_\_\_\_

- 
- <sup>18</sup>Hogan, Economic History, 1: pp. 42-48.
- <sup>19</sup>Brody, Steelworkers, pp. 10-11.
- <sup>20</sup>Warren, American Steel Industry, pp. 134-138.
- <sup>21</sup>Kallmann, "Steel on the Susquehanna," pp. 33-35; Maps of Steelton, Sanborn Map Company, New York, 1875 and 1896.
- <sup>22</sup>Hogan, Economic History, 1: pp. 23-24; Temin, Iron and Steel, pp. 214-218; United States Census Office, Twelfth Census: Manufactures, 11: Part 4, p. 39.
- <sup>23</sup>United States Census Office, Twelfth Census: Manufactures, 11: Part 4, p. 39; United States Census Office, Ninth Census: The Statistics of the Wealth and Industry of the United States (Washington, D.C.: 1872), 3: p. 603.
- <sup>24</sup>Temin, Iron and Steel, pp. 200-205; Warren, American Steel Industry, pp. 47, 110-112.
- <sup>25</sup>Warren, American Steel Industry, pp. 47-48; E. Willard Miller, Pennsylvania: Keystone to Progress (Northridge, Calif.: Windsor Publications, Inc., 1986), pp. 50-60; United States Census Office, Twelfth Census: Manufactures, 11: Part 4, pp. 693-695.
- <sup>26</sup>Mesabi ore at first had the disadvantage that it was exceptionally soft with an earth-like structure. The soft ore tended to clog iron blast furnaces and cause blowouts stopping the furnaces. After furnace developments prevented blowouts with this ore, its softness became an advantage because it could be easily dug. See Hogan, Economic History, 1: pp. 19-22, 203; Temin, Iron and Steel, pp. 195-199; Warren, American Steel Industry, p. 45.
- <sup>27</sup>Hogan, Economic History, 1: pp. 202-204; Kallmann, "Steel on the Susquehanna," pp. 34-35.
- <sup>28</sup>In tabulating the production totals by county, the 1890 United States Census apparently placed the Bethlehem Iron Company in Lehigh County, even though the plant was located just across the county line in Northampton County. See United States Census Office, Twelfth Census: Manufactures, Vol. 11, Part 4, pp. 8, 22.
- <sup>29</sup>United States Census Office, Twelfth Census: Manufactures, Vol. 11, Part 4, pp. 8, 22.

United States Department of the Interior  
National Park Service

**National Register of Historic Places  
Continuation Sheet**

Iron and Steel Resources of Pennsylvania, 1716-1945

E 120

Section number \_\_\_\_\_ Page \_\_\_\_\_

---

<sup>30</sup>Warren, American Steel Industry, pp. 47, 104-105; Hogan, Economic History, 1: pp. 54-56.

<sup>31</sup>Warren, American Steel Industry, pp. 145-146.

<sup>32</sup>United States Census Office, Twelfth Census: Manufactures, 11: Part 4, pp. 8, 22; Temin, Iron and Steel, p. 191; Warren, American Steel Industry, pp. 138-141, 170-175.

<sup>33</sup>Alfred D. Chandler, Jr., The Visible Hand: The Managerial Revolution in American Business (Cambridge: Harvard University Press, 1977), pp. 266-269.

<sup>34</sup>Chandler, The Visible Hand, pp. 259-262.

<sup>35</sup>Chandler, The Visible Hand, pp. 260-265

<sup>36</sup>Temin, Iron and Steel, pp. 175-176, 185-191.

<sup>37</sup>Hogan, Economic History, 1: pp. 257-265, 275-281, 292-296; Temin, Iron and Steel, pp. 190-191.

<sup>38</sup>Temin, Iron and Steel, pp. 191-193; Chandler, The Visible Hand, p. 361; Wall, Andrew Carnegie, pp. 780-790; Victor S. Clark, History of Manufactures in the United States (New York: Peter Smith, 1949 reprint of 1929 edition), pp. 55-57.

<sup>39</sup>Brody, Steelworkers, pp. 27-28.

<sup>40</sup>United States Census Office, Twelfth Census: Manufactures, 11: Part 4, pp. 5, 8.

<sup>41</sup>Brody, Steelworkers, pp. 29-31.

<sup>42</sup>Rules and Regulations, Carnegie Company, 1892, Charles M. Schwab Correspondence, and Sidney B. Whipple, "Notes on Mr. C.M. Schwab's Life," p. 24, Papers of the Bethlehem Steel Corporation, Acc. 1699, Hagley Library; Brody, Steelworkers, pp. 34-38.

<sup>43</sup>United States Census Office, Twelfth Census: Manufactures, 11: Part 4, p. 5; Brody, Steelworkers, pp. 40-49.

<sup>44</sup>Hogan, Economic History, 1: pp. 85-90; Brody, Steelworkers, pp. 50-51.



United States Department of the Interior  
National Park ServiceNational Register of Historic Places  
Continuation Sheet

Iron and Steel Resources of Pennsylvania, 1716-1945

E 121

Section number \_\_\_\_\_ Page \_\_\_\_\_

<sup>45</sup>Hogan, Economic History, 1: p. 229; Brody, Steelworkers, pp. 52-53.

<sup>46</sup>Foster Rhea Dulles and Melvyn Dubofsky, Labor in America: A History (Arlington Heights, Ill.: Harlan Davidson, 1984), pp. 157-159; Brody, Steelworkers, pp. 57-59.

<sup>47</sup>quote from Dulles and Dubofsky, Labor in America, p. 161. See also Dulles and Dubofsky, Labor in America, p. 162; Brody, Steelworkers, pp. 60-79, 81-85.

<sup>48</sup>quote from Brody, Steelworkers, p. 85. See also Brody, Steelworkers, pp. 31-32, 58-60, 85-88.

<sup>49</sup>John Bodnar, Immigration and Industrialization: Ethnicity in an American Mill Town, 1870-1940 (Pittsburgh: University of Pittsburgh Press, 1977), pp. 14-15, 22-25, 51-53, 62-65; Brody, Steelworkers, pp. 96-99.

<sup>50</sup>quote from John Bodnar, Immigration and Industrialization, p. 20. See also, Bodnar, Immigration and Industrialization, pp. 18-21, 78-82; Brody, Steelworkers, pp. 100-105.

<sup>51</sup>Bodnar, Immigration and Industrialization, pp. 102-126.

<sup>52</sup>Bodnar, Immigration and Industrialization, pp. 7-20; Brody, Steelworkers, pp. 87-89, 112-116, 123. Oligopoly, the Great Depression, and the Rise of Organized Labor, 1902-1945

Oligopoly, the Great Depression, and the Rise of Organized Labor, 1902-1945

<sup>1</sup>Chandler, The Visible Hand, p. 362; Hogan, Economic History, 2: 489-524; Hogan, Economic History, 3: pp. 899-918.

<sup>2</sup>Hogan, Economic History, 3: 1225-1226; Warren, American Steel Industry, pp. 154-156; "Review of the Commercial and Manufacturing Development of Bethlehem Steel Company, 1905-1940," Papers of the Bethlehem Steel Company, Acc. 1699, Hagley Museum and Library.

<sup>3</sup>Warren, American Steel Industry, pp. 156-157; Eugene L. DiOrio, Remarkable Past-Promising Future: Lukens, 1910-1985 (Phoenixville, Pa.: Lukens Corporate Public Relations Division, 1985), passim.

United States Department of the Interior  
National Park ServiceNational Register of Historic Places  
Continuation Sheet

Iron and Steel Resources of Pennsylvania, 1716-1945

E 122

Section number \_\_\_\_\_ Page \_\_\_\_\_

<sup>4</sup>Gary quoted in Brody, Steelworkers, p. 148. See also Brody, Steelworkers, pp. 149-152; Warren, American Steel Industry, p. 132; Richard A. Lauderbaugh, American Steel Makers and the Coming of the Second World War (Ann Arbor: UMI Research Press, 1980), pp. 123-124.

<sup>5</sup>Warren, American Steel Industry, pp. 195-211.

<sup>6</sup>United States Census Office, Twelfth Census: Manufactures, 11: Part 4, p. 958; United States Census Office, Sixteenth Census of the United States, Manufactures: 1939, Volume 2, Part 2: 946, 958; Hogan, Economic History, 2: 362; Hogan, Economic History, 3: 993-995.

<sup>7</sup>United States Census Office, Twelfth Census: Manufactures, 11: Part 4, p. 53; Hogan, Economic History, 3: 1119-1121, 1193-1194; Warren, American Steel Industry, pp. 240-242.

<sup>8</sup>Hogan quoted in his Economic History, 2: 662. See also Hogan, Economic History, 2: 671-673; Hogan, Economic History, 3: 879; Misa, "Industrial Structure," pp. 294-297; United States Census Office, Sixteenth Census, Manufactures, pp. 187-188.

<sup>9</sup>Warren, American Steel Industry, pp. 214-219, 222, 224-225; Hogan, Economic History, 3: 1149; United States Census Office, Sixteenth Census, Manufactures, pp. 187-188.

<sup>10</sup>Hogan, Economic History, 2: 717-729; Hogan, Economic History, 3: 1345-1359; United States Census Office, Sixteenth Census, Manufactures, pp. 187-188.

<sup>11</sup>Warren, American Steel Industry, pp. 178-180; Hogan, Economic History, 2: 428, 691; Hogan, Economic History, 3: 881-886, 1028, 1323-1329; United States Census Office, Sixteenth Census, Manufactures, pp. 187-188.

<sup>12</sup>Misa, "Industrial Structure," 114, 291-292; Warren, American Steel Industry, p. 243; Hogan, Economic History, 3: 1202, 1331; United States Census Office, Sixteenth Census, Manufactures, pp. 187-188.

<sup>13</sup>Warren, American Steel Industry, pp. 102, 107; Hogan, Economic History, 3: 1297-1305; United States Census Office, Sixteenth Census, Manufactures, pp. 187-188.

<sup>14</sup>Charles Schwab quoted in Sidney Whipple, "Notes on Mr. C.M. Schwab's Life," p. 213, Papers of the Bethlehem Steel Corporation, Acc.

United States Department of the Interior  
National Park Service

National Register of Historic Places  
Continuation Sheet

Iron and Steel Resources of Pennsylvania, 1716-1945

E 123

Section number \_\_\_\_\_ Page \_\_\_\_\_

1699, Hagley Library; Brody, Steelworkers, pp. 9-10; Misa, "Industrial Structure," p. 208.

<sup>15</sup>Hogan, Economic History, 3: 847-857; Warren, American Steel Industry, p. 215.

<sup>16</sup>Hogan, Economic History, 3: 1150-1161.

<sup>17</sup>Hogan, Economic History, 2: 431-432

<sup>18</sup>Hogan, Economic History, 2: 428; Robert Hessen, Steel Titan: The Life of Charles M. Schwab (New York: Oxford University Press, 1975), pp. 172-174.

<sup>19</sup>Hogan, Economic History, 2: 402-412; Hogan, Economic History, 3: 835-836, 1143-1144; United States Census Office, Sixteenth Census, Manufactures, p. 191

<sup>20</sup>Hogan, Economic History, 2: 414-418; Hogan, Economic History, 3: 836-839, 1145-1147; Historic Resource Survey Forms for Electric Reduction Company, Washington County, and Latrobe Electric Steel Company, Westmoreland County, prepared by Walter Kidney and Earl James, June 1987, on file at the Bureau for Historic Preservation, Harrisburg, Pennsylvania.

<sup>21</sup>Hogan, Economic History, 2: 391-398, 400; Hogan, Economic History, 3: 831-833, 1136; United States Census Office, Twelfth Census: Manufactures, 11: Part 4, pp. 37, 55, 67; United States Census Office, Sixteenth Census, Manufactures, p. 182-183.

<sup>22</sup>Hogan, Economic History, 2: 402; United States Census Office, Twelfth Census: Manufactures, 11: Part 4, p. 35; United States Census Office, Fifteenth Census, Manufactures, (Washington, D.C.: United States Government Printing Office, 1933), 2: 949; Sixteenth Census, Manufactures, p. 181; Historic Resource Survey Form for Shenango Furnace Company, Allegheny County, prepared by Walter Kidney, June, 1987, on file at the Bureau for Historic Preservation, Harrisburg, Pennsylvania.

<sup>23</sup>Warren, American Steel Industry, pp. 112-115; Hogan, Economic History, 2: 363, 378-389; Hogan, Economic History, 3: 825.

<sup>24</sup>Warren, American Steel Industry, pp. 145-148, 202-211, 244; United States Census Office, Twelfth Census: Manufactures, 11: Part 4, p. 8; Sixteenth Census, Manufactures, p. 191.

United States Department of the Interior  
National Park ServiceNational Register of Historic Places  
Continuation Sheet

Iron and Steel Resources of Pennsylvania, 1716-1945

E 124

Section number \_\_\_\_\_ Page \_\_\_\_\_

<sup>25</sup>Brody, Steelworkers, p. 147.

<sup>26</sup>Judge Gary quoted in Brody, Steelworkers, p. 153. Carnegie Company official quoted in C.L. Woodridge, "Industrial Housing," Yearbook of the American Iron and Steel Institute (1922), pp. 88-90. See also Brody, Steelworkers, pp. 153-156.

<sup>27</sup>Brody, Steelworkers, pp. 156-166, 178-179; John A Fitch, The Steel Workers (New York: New York Charities Publication Committee, 1911), passim; Dulles and Dubofsky, Labor in America, pp. 242-243; C.L. Woodridge, "Industrial Housing," p. 88.

<sup>28</sup>Brody, Steelworkers, p. 93; December 5, 1908 and March 29, 1910, Letters Books, M.L. Christman and William Smith, 1908-1929, Papers of the Phoenix Iron Company, Acc. 916, Hagley Museum and Library. Hagley Museum and Library;

<sup>29</sup>Brody, Steelworkers, pp. 166-168; General Plan of Safety and Welfare Work at the Bethlehem Steel Company, November 26, 1913, Charles M. Schwab Correspondence, Papers of the Bethlehem Steel Company, Acc. 1699, Hagley Museum and Library.

<sup>30</sup>Brody, Steelworkers, pp. 168-169.

<sup>31</sup>Riley quoted in Yearbook of the American Iron and Steel Institute (1922), p. 120. See also Brody, Steelworkers, pp. 87-89; John Yetter, Steelton, Pennsylvania: Stop, Look, Listen (Harrisburg: Triangle Press, 1979), p. 105.

<sup>32</sup>C.L. Woodridge, "Industrial Housing," pp. 92-97, 100-103; Brody, Steelworkers, pp. 88-89.

<sup>33</sup>Schwab quoted in Sidney Whipple, "Notes on Mr. C.M. Schwab's Life," p. 72, Papers of the Bethlehem Steel Corporation, Acc. 1699, Hagley Library. See also Brody, Steelworkers, pp. 225-230, 268-269; Hogan, Economic History, 3: 862-870.

<sup>34</sup>Worker quoted in Fitch, Steel Workers, p. 225. See also Brody, Steelworkers, pp. 112-118, 121-124.

<sup>35</sup>Brody, Steelworkers, pp. 120-121; Fitch, Steel Workers, p. 349.

<sup>36</sup>Fitch, Steel Workers, p. 349.

United States Department of the Interior  
National Park Service

**National Register of Historic Places  
Continuation Sheet**

Iron and Steel Resources of Pennsylvania, 1716-1945

E 125

Section number \_\_\_\_\_ Page \_\_\_\_\_

---

<sup>37</sup>Brody, Steelworkers, pp. 106-111, 185-187, 265-268; Hogan, Economic History, 3: p. 861.

<sup>38</sup>Judge Gary quoted in Brody, Steelworkers, p. 275. Schwab quoted in Sidney Whipple, "Notes on Mr. C.M. Schwab's Life," p. 73, Papers of the Bethlehem Steel Corporation, Acc. 1699, Hagley Library. See also Brody, Steelworkers, pp. 175-177.

<sup>39</sup>Brody, Steelworkers, pp. 67-78, 140-145.

<sup>40</sup>Brody, Steelworkers, pp. 180-190

<sup>41</sup>Brody, Steelworkers, pp. 190-197, 202-210; Dulles and Dubofsky, Labor in America, pp. 215-220.

<sup>42</sup>Brody, Steelworkers, pp. 214-240; Hogan, Economic History, 2: 456-458.

<sup>43</sup>Brody, Steelworkers, pp. 240-262; Dulles and Dubofsky, Labor in America, pp. 225-227; Hogan, Economic History, 2: 458-459.

<sup>44</sup>Brody, Steelworkers, pp. 265-278; Hogan, Economic History, 3: 861-874.

<sup>45</sup>Dulles and Dubofsky, Labor in America, pp. 255-267.

<sup>46</sup>Dulles and Dubofsky, Labor in America, pp. 278-289; Hogan, Economic History, 3: 1169-1171.

<sup>47</sup>Dulles and Dubofsky, Labor in America, pp. 289-295; Hogan, Economic History, 3: 1171-1178.

<sup>48</sup>Hogan, Economic History, 3: 1178-1183.

<sup>49</sup>Hogan, Economic History, 3: 1184.

**United States Department of the Interior  
National Park Service****National Register of Historic Places  
Continuation Sheet**

Iron and Steel Resources of Pennsylvania, 1716-1945

F.2 1

Section number \_\_\_\_\_ Page \_\_\_\_\_

## DESCRIPTION

The iron industry property type includes a broad array of resources that range in time and size from eighteenth century stone furnace stacks occupying less than an acre, to nineteenth century iron plantations comprising a furnace, buildings and archaeological remains covering dozens of acres, to early twentieth century iron clad, merchant iron furnaces.

The iron industry property type includes production facilities directly related to the production of iron, including the manufacture of iron from raw materials into products ranging from molten iron and pigs to stove plates, cannon and ingots. These resources included the following types of structures, buildings and sites: iron furnace stacks or blast furnaces, engine houses, bridge houses, charcoal houses, stock houses, regenerative stoves, livestock barns or stables, casting sheds, bloomery forges (consisting of a water powered tilt hammer and hearth for heating and beating iron ore), rolling mills, slitting mills, blacksmith shops, storage sheds, storage pits, machinery, roads, tramways, railroad tracks or beds, iron mines or iron pits, and slag piles.

Furnace stacks constructed of stone formed the functional heart of production facilities during the eighteenth to mid-nineteenth centuries. The stone surrounded a cylindrical, tapered bosh made of fire-resistant stone or bricks. They were most often constructed as truncated pyramids with rectangular bases; sometimes these pyramids incorporated ledges built into one or more sides of the stack. A small number of furnaces were built as tapered cylinders. The exact shape of most furnace exteriors was determined by the stonemasons who constructed the furnace. Furnaces were typically thirty to thirty five feet tall and rectangular ones were twenty-seven to thirty feet square. Furnaces also had from two to six arches or triangular openings in their bases. Iron from the bosh or widest part of the void inside the furnace was tapped at the "fore arch." Air was blasted into the bosh through pipes called tuyeres that entered the bosh through other arches. Large bellows, then wooden tubs with pistons inside, and finally large metal blowing engines pumped air into the tuyeres. Water wheels and then steam engines powered these pumps. On top of hot blast furnaces or next to them on the ground were ovens or pipes that preheated air before it was fed through the tuyeres into the bosh. Furnaces were usually built into the sides of earthen banks with ramps or covered ramps called bridge houses running from the lip of the bank to the top of the furnace. Workers carried raw

**United States Department of the Interior  
National Park Service****National Register of Historic Places  
Continuation Sheet**

Iron and Steel Resources of Pennsylvania, 1716-1945

F.2 Page 2

Section number \_\_\_\_\_ Page \_\_\_\_\_

materials in baskets or wheel barrows across ramps and dumped the materials into the circular opening in the top of the stack. Casting sheds made of wood or in a few cases stone extended from one or more sides of the furnace base. These sheds were generally utilitarian structures with earthen floors on which iron pigs or other objects were cast.

Blast furnaces built during the later nineteenth and early twentieth centuries were large, metal cylinders encasing refractory brick that contained the molten iron and raw materials. Conveyors, elevators or skip loaders carried raw materials up the sides of the furnace to be dumped into the top of the furnace. Numerous tuyeres fed hot air into the bases of these furnaces, where holes for tapping the furnace were also located. The tuyeres were connected to tall (up to one hundred feet high), cylindrical stoves arranged often in a row next to the furnace. These regenerative stoves preheated the air that was fed into the furnace. A casting shed with dirt floor skirted the base of furnace; iron flowing from the furnace was either cast into pigs or other objects.

Eighteenth to mid-nineteenth century furnaces were also surrounded by other production buildings such as charcoal houses, cast houses, engine houses, stables, blacksmith shops and machinery. At charcoal furnaces rectangular charcoal houses usually constructed of stone walls and wooden roofs were used to store charcoal that fueled these furnaces. Cast houses were usually rectangular buildings made of wood and attached to the base of the furnace stack. Pig iron and iron implements were cast in cast houses. Engine houses were rectangular, stone, brick or wooden buildings that contained steam engines used to power machinery, particularly blowing engines, at furnaces beginning in the mid-nineteenth century. Stables were rectangular stone, brick or wood buildings that sheltered animals used in the transport of raw materials and products to and from the furnace. Blacksmith shops were small rectangular buildings in which tools and other items were repaired or made. Slitting mills were rectangular wood or masonry buildings that contained rollers for shaping thin iron products such as rods. Later rolling mills were rectangular wood or masonry buildings housing larger rolling machinery for rolling a variety of shapes. Some rolling mills were over one hundred feet long. Other machinery might also be located near the furnace.

Late nineteenth and early twentieth century blast furnaces were surrounded by engine houses, skip hoists, stock houses, stables, blacksmith shops, storage pits, and machinery. The various buildings were rectangular in shape and constructed of stone, brick or wood.

**United States Department of the Interior  
National Park Service****National Register of Historic Places  
Continuation Sheet**

Iron and Steel Resources of Pennsylvania, 1716-1945

F.2

3

Section number \_\_\_\_\_ Page \_\_\_\_\_

Engine houses were often large buildings housing enormous blowing engines. Stock houses containing coal, iron or other raw materials could also be large edifices. At some furnaces open storage pits contained raw materials. By the early twentieth century skip hoists hauled cars filled with raw materials up an incline to the top of the furnace for loading. Machinery such as engines could also be found near these blast furnaces.

Roads, railroads or tramways extended away from the furnaces and adjacent buildings and structures. Railroads and roads connected to transportation networks. These transportation routes enabled workers to bring raw materials to the furnace and carry away finished products. Often roads, tramways and railroads extended alongside or into buildings or storage pits. In a few cases a canal passed close to the furnace. At some furnaces, roads, railroads or tramways also led to iron mines or iron pits located within several miles of the furnace. These shaft mines and pits could be several dozen or several hundred feet long and deep. For example, numerous small, shallow pits could be scattered through an iron ore deposit, or one gigantic iron pit could be found at the end of the road or railroad.

Iron production facilities were generally laid out in similar ways. The majority of such facilities usually centered around one furnace, although in a minority of cases two to four furnaces were built adjacent to each other or physically coupled with each other. Engine houses, casting sheds, bridge houses, charcoal houses, stock houses, storage sheds, storage pits, and machinery were attached to or located close by the furnaces. Slag piles were also located adjacent to furnaces. Roads, railroads or tramways extended out from the buildings and structures. Iron pits or mines were sometimes located within several miles of the furnace. At charcoal furnaces forests originally surrounded the furnaces, and then were clear cut as the furnaces consumed charcoal.

Most successful furnaces were located nearby high-quality iron ore deposits. Iron production facilities were located by streams which powered machinery, especially blowing machinery, at the furnace. Eighteenth to mid-nineteenth century charcoal furnaces were located in forests. Furnaces were also generally located near transportation arteries such as railroads, roads and canals.

Today many of the resources once associated with iron production facilities no longer remain, or may be greatly deteriorated or in ruins. Of the various buildings, structures and sites originally built for these facilities, stone furnace stacks are the most likely to still remain. Furnace stacks may be largely intact, or they may have corners, sides or arches that have partially or completely collapsed. Furnace



United States Department of the Interior  
National Park Service**National Register of Historic Places  
Continuation Sheet**

Iron and Steel Resources of Pennsylvania, 1716-1945

F.2 4

Section number \_\_\_\_\_ Page \_\_\_\_\_

stacks may also have been rebuilt or replaced during the operation of the iron production facilities. Most of the late nineteenth and early twentieth century metal blast furnaces have been demolished. At Robesonia Furnace only the foundations of the early twentieth century furnace remain. At some sites one or more of the associated production buildings and structures, such as charcoal houses, casting sheds, and engine houses may still stand substantially intact. However, it is more frequently the case that most of these buildings and structures survive only as ruins, or that no above-ground trace of them can be found. Often only the partial walls or foundations of some of these buildings and structures remain adjacent to the furnace stack. In a few rare cases machinery may stand nearby the furnace, such as the blowing engine and boilers at Carrick Furnace. Few if any forges, rolling mills or slitting mills are known to survive. Slag piles are commonly found nearby the locations of iron production facilities. Below ground remains of production facilities may include foundations or foundation stones of buildings and furnace stacks, slag deposits, pieces of iron made at the furnace, and fragments of machinery. The road beds of railroads, tramways or roads can also be found leading from furnaces or former, associated buildings and structures. Woodlands that were once clear cut have since grown over or been developed. Iron mines or ore pits have often been partially or completely filled in through subsidence or deliberate filling.

In addition to production facilities, the iron industry property type includes the buildings and structures erected to serve the residential, educational, commercial, agricultural and religious needs of the workers and ironmaster who often lived nearby the iron production facilities. Since iron furnaces were often constructed in rural areas with few or no houses, churches, schools or stores nearby, furnace owners frequently built iron plantations to satisfy these needs. They erected on their plantations one or more of the following types of buildings: workers' houses, ironmaster's houses, schools, churches, grist mills, barns, stores, furnace office, and outbuildings such as smokehouses, springhouses and carriage sheds. The number of such buildings established on an iron plantation could range from a single ironmaster's house to dozens of workers' houses and other commercial, educational and religious buildings. Most iron plantations were built during the eighteenth to mid-nineteenth centuries. By the late nineteenth century furnace owners created fewer iron plantations because furnaces were increasingly erected nearby already established towns.

Residential needs were served by ironmasters' houses and workers' houses. The ironmaster's house where the owner or manager of the iron production facilities and iron plantation lived was usually the largest

**United States Department of the Interior  
National Park Service****National Register of Historic Places  
Continuation Sheet**

Iron and Steel Resources of Pennsylvania, 1716-1945

F.2 5

Section number \_\_\_\_\_ Page \_\_\_\_\_

house on the plantation. Constructed of stone, wood or brick, these houses were often large enough to be called mansions by local residents. Some ironmasters' houses, especially those constructed during the eighteenth century and at smaller iron production facilities, were vernacular in appearance with little architectural embellishment. Later ironmasters' houses, especially those at more prosperous production facilities, were often constructed in period high styles or with high style elements popular in Pennsylvania at given periods. Mansions in such styles as the Federal, Italianate and Gothic Revival were built on some plantations during the nineteenth century. By comparison, workers' houses tended to be smaller and much more plain buildings. Built most often of wood, but occasionally of stone or brick, these rectangular residences were generally vernacular buildings erected with little or no architectural ornamentation. These houses were constructed as detached, duplex, and multi-unit dwellings.

Educational and religious needs were met by schools and churches. These edifices were constructed in wood, stone and brick, and were often among the larger buildings on a big plantation. Frequently these buildings, especially schools, were plain vernacular buildings. However, some buildings, particularly churches dating from the mid- to late-nineteenth century, were built in high styles or with high style architectural elements.

Commercial and agricultural buildings were generally functional in appearance. Commercial buildings consisted of a plantation store, or a furnace office. Built of wood, stone or brick, these buildings were usually vernacular with little high style embellishment. The largest agricultural buildings were barns, built in forms such as the Pennsylvania bank barn. At some plantations rectangular, vernacular grist mills were erected to grind grain that was grown on the plantation farm.

Outbuildings such as springhouses and smokehouses were built of wood, stone or brick, and were small and plain in appearance. Carriage houses at some plantations were built of wood, stone or brick, and especially at mid- to late-nineteenth century plantations, echoed the architectural styling of the ironmaster's house.

Iron plantations varied greatly in size and layout. They ranged in size from a few acres containing an ironmaster's house or a handful of workers' houses to hundreds of acres containing houses, a church, schools, barns, a store, grist mill, other buildings, and farm fields. The buildings were most often located nearby the furnace. When the furnace was built in a narrow stream valley, buildings were often

**United States Department of the Interior  
National Park Service****National Register of Historic Places  
Continuation Sheet**

Iron and Steel Resources of Pennsylvania, 1716-1945

F.2                      6

Section number \_\_\_\_\_ Page \_\_\_\_\_

constructed immediately up or down stream from the furnace. In wider valleys where more flat or gently sloping terrain was available, buildings were built in rows along roads stretching away from the furnace, or along roads arranged in rough grids or circles nearby the furnace. Smaller clusters of houses and other buildings were sometimes constructed away from the furnace near ore pits or mines. Farm fields also stretched away from the furnace and barns at some plantations.

Many of the resources at most iron plantations have disappeared. The buildings most likely to remain from iron plantations are the ironmaster's house or mansion. Many of these houses stand today in much of their original appearance; some, however, may have been altered by additions, new porches and dormers, window replacements, and renovations of interiors. Churches, schools, stores, grist mills, barns, workers' housing and outbuildings that survive have frequently been altered with additions, residing, new porches, window replacements and renovations of interiors. Former rows of workers' houses may today have only a few houses left with gaps that once contained houses in between them. Frequently all that remains of plantation buildings are the stone foundations that may be arranged along former road beds. Especially in areas that have been developed since the furnace stopped operation, newer noncontributing buildings may have been interspersed among the buildings or foundations of the plantation. Below ground remains of iron plantations may include foundations or foundation stones, deposits of china, glass, kitchen utensils and other artifacts used at home by furnace workers, and middens.

The boundaries of resources included in this property type will contain those remains that contribute to the historic or archaeological significance of the site as outlined in the significance section and registration requirement section. Boundaries may incorporate less than an acre where a furnace stack stands, or over a hundred acres where a historic district of plantation buildings or building remains are found. Boundaries may also include iron ore mines or ore pits. The exact location of boundaries will be determined primarily by the location of above and below ground remains, natural features such as ridge lines, streams, and iron ore deposits, man-made features such as roads, and political boundaries such as property parcel boundaries. Generally boundaries will not include large expanses of woodlands that were once cut over or owned as part of the iron production facilities; the exact limit of the land that was cut over or owned by the furnace is often not known.

United States Department of the Interior  
National Park ServiceNational Register of Historic Places  
Continuation Sheet

Iron and Steel Resources of Pennsylvania, 1716-1945

F.3 7

Section number \_\_\_\_\_ Page \_\_\_\_\_

## SIGNIFICANCE

The iron industry property type includes resources significant under a variety of areas of significance and National Register Criteria A, B, C, and D (see also Registration Requirements). Significance was generally evaluated in comparison to other properties statewide (see also Methodology).

Resources in the iron industry property type are significant under Criterion A in association with one of Pennsylvania's foremost industries historically. Pennsylvania has been widely recognized as the historical center of the nation's iron industry. For over one hundred years the Commonwealth produced more iron and employed more workers in this industry than any other state. Pennsylvania has also hosted more technological innovations, such as the development of iron furnaces fueled by anthracite coal to the first commercially successful production of steel. In addition, the Commonwealth has been the home of some of the largest iron companies in the nation. Resources in this property type are associated with important events, activities, and developments. They include resources related to the initial establishment of Pennsylvania iron manufacture along eastern creeks and streams, the westward expansion of iron production with its clusters of regional iron producers, such as in the Juniata Valley and Fayette County. Some resources relate to the introduction of new technologies such as the adoption of anthracite coal and coke as smelting fuels, and the production of iron and iron products to meet the needs of a growing population. Examples of iron industry properties significant under Criterion A include Mount Etna Furnace in the Juniata Valley as an example of the westward expansion of the iron industry, and Farrandsville Furnace in Clinton County as an example of early coke experimentation. Dale Furnace and Forge in Berks County is a good example of the early establishment of the iron industry in eastern Pennsylvania. Iron plantations may be eligible as representatives of iron companies' efforts to build company-owned towns, incorporating educational, religious, residential, commercial and agricultural functions. Robesonia Furnace Historic District in Berks County and Mount Hope Furnace Historic District in Lancaster County are examples of such iron plantations.

The iron industry property type includes resources significant under Criterion B which are associated with individuals who were progenitors of the State's iron industry. This includes individuals such as Peter Grubb, Thomas and Samuel Potts, Robert Coleman, and Isaac Meason, who were significant in the establishment, promotion, and growth

United States Department of the Interior  
National Park Service

## National Register of Historic Places Continuation Sheet

Iron and Steel Resources of Pennsylvania, 1716-1945

F.3 8

Section number \_\_\_\_\_ Page \_\_\_\_\_

---

of iron manufacturing within given regions. An example of a property significant under Criterion B is Mount Vernon Furnace in Fayette County, which was associated with Isaac Meason, the most notable of the western Pennsylvania ironmasters.

The iron industry property type also includes resources significant under Criterion C such as production facilities which display exceptional craftsmanship (Farrandsville Furnace masonry), retain rare and in situ machinery (Carrick Furnace in Franklin County and Eliza Furnace in Cambria and Indiana Counties), are exceptionally well preserved or unusually configured (the round stack of Codurus Furnace in York County, the four contiguous stacks of the Lackawanna Iron and Coal Company Furnaces in Lackawanna County), and architectural resources, particularly ironmasters' mansions, which are distinctive most often of local vernacular architecture (Dale Furnace and Forge, and Swatara Furnace in Schuylkill County).

Finally, the iron industry property type includes resources significant under Criterion D for their archaeological importance. This includes undisturbed archaeological remains which may yield important information about the site. This information could be helpful by suggesting the size and configuration of lost buildings. Information about metallurgical advances might be gleaned through recovery of pigs, while data about products, cast goods or tools, and the corroboration of technological modification, such as the subsurface remains of hot blast or steam engine equipment could also be gained. Also, information about the lives of the iron workers and the ironmasters could be gleaned from archaeological investigation. Examples of properties significant under this criterion include the anthracite furnaces of the Chickies Industrial Historic District in Lancaster County, and sites such as Alliance Furnace in Fayette County, which is one of the earliest western Pennsylvania furnaces and is located in an area undisturbed since its demise.

United States Department of the Interior  
National Park ServiceNational Register of Historic Places  
Continuation Sheet

Iron and Steel Resources of Pennsylvania, 1716-1945

F.4 9

Section number \_\_\_\_\_ Page \_\_\_\_\_

## REGISTRATION REQUIREMENTS

## CRITERION A

## Area of Significance: Industry

To be eligible for registration a resource must have a strong association with the iron industry. It must have manufactured raw materials into iron products such as molten iron, pig iron, stove plates or cannons, or have been directly related to the manufacture of iron. It must have been associated with iron production between the early eighteenth century and the early twentieth century. Resources which played a key role in shaping important events, activities and developments will be eligible as will those which are clearly representative of important patterns in the history of Pennsylvania ironmaking. Resources of the iron industry property type which are eligible under other Criteria and Areas of Significance will generally also be eligible under Industry.

## Area of Significance: Community Planning and Development

To be eligible for registration a resource must represent ironmasters' efforts to build villages or plantations for workers and themselves. It must represent the educational, religious, residential, commercial or agricultural functions of the iron villages or plantations.

## Integrity:

Buildings and structures included in this property type that are significant under Criterion A must retain much of their historic design and feeling. It is very important that the form and function for which the buildings or structures are significant must be readily apparent. For example, the rectangular shape and massive walls of an iron furnace stack must be apparent, even though the furnace walls or top of the furnace may have partially collapsed.

The nominated property does not have to retain all or even most of the original buildings and structures in order to be eligible for the National Register under Criterion A. At most iron production facilities and iron plantations, many of the buildings and structures have been demolished or have collapsed over time.

Buildings and structures must retain their predominant historic materials.

United States Department of the Interior  
National Park ServiceNational Register of Historic Places  
Continuation Sheet

Iron and Steel Resources of Pennsylvania, 1716-1945

F.4 10

Section number \_\_\_\_\_ Page \_\_\_\_\_

The iron industry property type may also remain eligible under Criterion A despite significant changes to the setting. Settings of iron production facilities and iron plantations have often been greatly altered over time. For example, the hundreds of acres of woodlands that may have been clear cut around a charcoal furnace may have since grown over with trees. Similarly, twentieth century development may now abut iron plantations that were originally built in isolated areas.

Buildings and structures must have integrity of location. Buildings or structures moved after their period of significance should be considered noncontributing if they have been moved from their position relative to other contributing resources on the nominated property. For example, a worker's house that once stood in a row of workers' houses will be noncontributing if it is moved away from all other workers' houses on a former iron plantation. Buildings and structures moved during the period of significance will be contributing if the resources were integral to the property's historic significance after the move.

## CRITERION B

Area of Significance: Industry

To be eligible under Criterion B a resource must be associated with an individual(s) who made an important contribution(s) to the history of ironmaking in Pennsylvania. The individual should stand out among his peers in association with important events, activities or developments, such as:

the management of a major iron company in Pennsylvania;

the invention or establishment of significant innovations in iron making;

the production of significant types of iron products;

leading the development of a major iron producing region.

## Integrity:

Integrity of association is highly important for buildings or structures that are significant under Criterion B. Such buildings or structures must have strong association with the significant individual. The resource should be associated with the person's period of achievement, unless it is the only extant property known to be

United States Department of the Interior  
National Park Service

National Register of Historic Places  
Continuation Sheet

Iron and Steel Resources of Pennsylvania, 1716-1945

F.4 11

Section number \_\_\_\_\_ Page \_\_\_\_\_

---

associated with the person's life. If more than one building or structure is associated with the person's period of achievement, the resources should be compared to determine whether they represent different aspects or phases of a person's productivity. A property associated with a minor facet of a person's life will not be eligible. For example, the retirement home of an important ironmaster would not be eligible under Criterion B, if other properties exist representing his productive career.

Buildings and structures that are significant under Criterion B must retain much of their historic design, workmanship, materials, and feeling; these historic physical characteristics must be readily apparent. Additions which greatly compromise the historic integrity of the exterior can make the building or structure ineligible for the National Register. Substantial alterations to the interior, such as major changes in the floorplans, may also make the resource ineligible.

Buildings and structures must retain their original location. For example, the house of a significant ironmaster would not be eligible under Criterion B if moved away from associated resources of the iron plantation.

CRITERION C

Area of Significance: Architecture

The iron industry property type can be eligible for the National Register under Criterion C in the area of architecture if it includes buildings that represent distinctive characteristics of a type, period or method of construction. In particular, ironmasters' houses may represent the characteristics of an architectural style or type of vernacular architecture popular in Pennsylvania during a given period. Other residential, educational, religious or commercial buildings included in this property type may also represent such styles or types of vernacular architecture.

Area of Significance: Engineering

The iron industry property type may be eligible for listing under engineering as being representative of important engineering techniques used in the construction of iron production facilities, particularly iron furnace stacks and blast furnaces. For example, an iron furnace may be important as a well preserved example of eighteenth to mid-nineteenth century rectangular, stone furnace construction.



United States Department of the Interior  
National Park ServiceNational Register of Historic Places  
Continuation Sheet

Iron and Steel Resources of Pennsylvania, 1716-1945

F.4 Page 12

Section number \_\_\_\_\_ Page \_\_\_\_\_

## Integrity:

Properties eligible for the National Register under Criterion C in the area of architecture must retain the characteristics of the style or type of architecture for which they are being nominated. These characteristics include the design, workmanship, and materials of the style or type of architecture. For example, an ironmaster's house associated with the characteristics of a particular high style, such as the Federal style, must retain the distinguishing features of that style. Additions to buildings must not be so large or situated in such a way as to largely obscure these characteristics. For instance, an addition situated on the front elevation of a Federal style ironmaster's house that obscures half the elevation would make the building ineligible for the National Register.

Buildings and structures eligible for the National Register in the area of engineering must display the engineering techniques, including the design, materials, and workmanship for which they are being nominated. For example, a stone iron furnace stack must retain its distinguishing engineering design, materials and workmanship including intact stone walls, rectangular or cylindrical shape, and cast and tuyere arches.

Buildings and structures whose design was a reflection of their immediate environment must have integrity of location and setting.

## CRITERION D

Area of Significance: Historic--Non-Aboriginal

The above or below ground remains of the iron industry property type may be eligible for listing on the National Register under Criterion D for the information they may yield about the manufacture of iron, the layout and scale of this property type, and the lives of the people who lived and worked at this property type.

Sites of iron production facilities may be significant under Criterion D for the information they may yield about the manufacture of iron. The study of slag deposits above or below ground at these facilities can offer information about how the process of manufacturing changed over time. Analysis of the color and type of slag (glossy or porous) denotes the type of blast (i.e. hot blast or cold blast) and the type of ore used. The study of remains of iron products manufactured at a facility can aid our understanding of what was made at the facility when, and what the quality of those products was. Such analysis of slag

United States Department of the Interior  
National Park ServiceNational Register of Historic Places  
Continuation Sheet

Iron and Steel Resources of Pennsylvania, 1716-1945

F.4 13

Section number \_\_\_\_\_ Page \_\_\_\_\_

and products can in turn aid our understanding of the decline or rise of iron production at a given facility or in an iron production region. The analysis of remains of iron production machinery found above or below ground may assist in understanding how iron was made.

Remains of the iron industry property type may also provide information on the scale and layout of this property type. Above or below ground foundation remains, for example, may indicate how workers' houses were laid out and what their spatial relationship to the furnace stack and ironmaster's house was. Similarly, remains of tramways, roads or railroads that tied iron mines to the furnace stack may help indicate the sometimes large geographic area spanned by iron production facilities. Through dating of such remains, the physical expansion or contraction of iron plantations and iron production facilities over time may also be understood.

Below ground remains of pottery, glass, other household artifacts, and middens can also provide information on the daily lives of inhabitants at this property type. For example, remains of household artifacts and middens may provide information on their standards of living, diets, health, clothing, purchasing or trade patterns, family structure.

## Integrity:

Archaeological remains must have integrity of association. They must be conclusively identified as being associated with a particular iron production facility or iron plantation through the use of written records, local oral history informants, or archaeological excavation. Archaeological remains must also be conclusively identified as to their type or function; for instance, remains could be identified as the foundation of the iron furnace stack, the foundations of workers' houses, or the fragments of household artifacts used by workers' families.

Archaeological remains, particularly below ground remains, must have excellent integrity of location; physical remains cannot have been moved from their historic locations. The immediate setting should have little or no surface disturbance.

If the iron industry property type is eligible under Criterion D because it reveals information on the scale and layout of this property type, remains of all of the original buildings and structures need not be present. It is not necessary that remains identify every row of workers housing or road that once existed in an iron plantation, for

**United States Department of the Interior  
National Park Service**

**National Register of Historic Places  
Continuation Sheet**

Iron and Steel Resources of Pennsylvania, 1716-1945

F.4 14

Section number \_\_\_\_\_ Page \_\_\_\_\_

---

example. However, enough clearly identified remains should be found over a large enough area (integrity of design and materials) to denote the overall scale or layout of the iron industry property type. Similarly, sites do not have to have the remains of all original slag deposits in order to be eligible for the information that such deposits may yield about the production of iron.

---

**G. Summary of Identification and Evaluation Methods**

---

Discuss the methods used in developing the multiple property listing.

See continuation sheet

---

**H. Major Bibliographical References**

---

See continuation sheet

Primary location of additional documentation:

- State historic preservation office  
 Other State agency  
 Federal agency

- Local government  
 University  
 Other

Specify repository: \_\_\_\_\_

---

**I. Form Prepared By**

---

name/title Bruce Bomberger, William Sisson, Diane Reed/Preservation Specialists  
organization Bureau for Historic Preservation/PHMC date May, 1991  
street & number Box 1026 telephone (717) 783-8946  
city or town Harrisburg state PA zip code 17108-1026

**United States Department of the Interior  
National Park Service**

**National Register of Historic Places  
Continuation Sheet**

IRON AND STEEL RESOURCES IN PENNSYLVANIA 1716-1945

Section number     G     Page     1    

METHODOLOGY

The multiple property nomination of iron sites in Pennsylvania includes the historic remains of the iron and steel industries from 1716 to 1945. The nomination was prepared by the Bureau for Historic Preservation of the Pennsylvania Historical and Museum Commission with funding from the America's Industrial Heritage Project. The industrial survey team consisted of Bruce Bomberger and William Sisson, who prepared the context on the iron and steel industry, and Diane Reed, who conducted the field survey work and prepared the individual National Register nominations of iron industry properties. Greg Ramsey participated in the review and editing of the context and individual nominations.

The project began in February of 1989. The first phase was the consideration of iron related properties, with the second phase to be the examination of steel sites. In the nomination of iron-related resources, priority would be given to properties which included iron production facilities or remains. Assembly of existing data began with iron sites which had previously been identified in the Commonwealth's historic resource survey. This included 56 properties, 25 of which were also listed on the National Register. All files associated with these properties were reviewed to familiarize the surveyor with the types of properties that had been surveyed, as well as for evaluation for inclusion in the multiple property nomination. Properties which were already listed on the National Register were reviewed to provide a perspective for potential nominations. Those properties previously listed on the National Register are:

<u>property</u>	<u>county</u>
Brady's Bend Iron Company Furnaces	Armstrong
Hopewell Furnace National Historic Site	Berks
Joanna Furnace Complex	Berks
Sally Ann Furnace Complex	Berks
Etna Furnace	Blair
Centre Furnace Mansion House	Centre
(Curtin Village) Eagle Iron Works	Centre
Harmony Forge Mansion	Centre

United States Department of the Interior  
National Park Service

# National Register of Historic Places Continuation Sheet

IRON AND STEEL RESOURCES IN PENNSYLVANIA 1716-1945

Section number          <sup>G</sup> Page          <sup>2</sup>

<u>property</u>	<u>county</u>
Reading Furnace Historic District	Chester
Warwick Furnace/Farms	Chester
Hatfield/Hibernia Historic District	Chester
Pine Grove Furnace	Cumberland
Barree Forge	Huntingdon
Colerain Forges	Huntingdon
Greenwood Furnace	Huntingdon
Huntingdon Furnace	Huntingdon
Juniata Iron Works	Huntingdon
Monroe Furnace	Huntingdon
Paradise Furnace	Huntingdon
Pennsylvania Furnace	Huntingdon
Rockhill Furnace II	Huntingdon
Mt. Hope Estate	Lancaster
Cornwall Furnace National Hist. Landmark	Lebanon
Lock Ridge Furnace Complex	Lehigh
Laurel Hill Furnace	Westmoreland

In addition to reviewing PHMC files, the surveyor contacted resource people knowledgeable about iron sites in various regions of the state, as well as other agencies and professionals. These included local and regional historical societies, museum and archival resources, the Historic American Engineering Record (HAER) and local survey projects.

In order to make a preliminary selection of sites to be considered for the multiple property nomination, the following criteria were utilized.

1. integrity of the site
2. historical significance
3. architectural significance
4. technological significance
5. association with prominent person(s)
6. significance in labor history
7. significance in ethnic and/or immigration history

United States Department of the Interior  
National Park ServiceNational Register of Historic Places  
Continuation Sheet

IRON AND STEEL RESOURCES IN PENNSYLVANIA 1716-1945

Section number     G     Page     3    

From the review of the PHMC files and the recommendations of various resource people and organizations, a list of potentially significant properties was prepared. The list was not intended to include all iron-related properties that might be eligible for the National Register, but rather to focus on the most significant in the Commonwealth, given the time restrictions of the project. A list of 30 properties was prepared, including 14 properties which had not previously been surveyed. Those properties, and others which had been previously surveyed but required additional documentation were visited, photographed and researched. Data was drawn from secondary sources, such as county histories, and histories of the iron industry. However, primary sources were consulted wherever available. Among the facilities utilized for primary research sources were the Pennsylvania Archives, Hagley Museum and Library, The Historical Society of Pennsylvania, and a number of local historical societies.

Industrial survey forms and attendant documentation were prepared for 29 of those sites (the other site documentation being prepared by Dr. June Evans for Lancaster Parks and Recreation under a NPS/PHMC Survey and Planning Grant), and were presented to staff committee on June 18, 1990 for determinations of eligibility, based on the registration requirements as described in this nomination. In addition, integrity was a consideration. The level of integrity was determined by a combination of factors, including age and rarity of the resource, emphasis being given to properties which were substantially unaltered. There was an effort to include properties which were representative of types and styles, as well as addressing the geographic representation of the iron industry. Of those considered, 22 were determined to be significant in a statewide context. Seven properties were not included for nomination, based on deteriorated condition, lack of integrity, or because they were not considered to be historically or technologically significant based on available data.

United States Department of the Interior  
National Park Service

**National Register of Historic Places  
Continuation Sheet**

IRON AND STEEL RESOURCES IN PENNSYLVANIA 1716-1945

Section number          <sup>G</sup> Page          <sup>4</sup>

---

In two cases existing National Register boundaries were revised to reflect further survey work (Etna and Mount Hope Furnaces). Site visits were conducted by the staff and a member of the Historic Preservation Board in the case where boundaries of the historic districts needed to be identified or clarified due to questions of integrity of resources in the district, or to protect the integrity of the district.

The iron context was developed consisting of three periods in the development of the industry; Ancient Technology, 1716-1783; Adjustment, Migration and Progress, 1784-1830; and Mineral Fuel, Integration, and Soaring Production, 1831-1866. Although there was discussion of developing several property types associated with the iron industry, it was determined that all the iron resources revolved around the iron plantation. Even in cases where the only element extant or nominated was the furnace stack, all resources were an integral element of what was originally an iron plantation. It was determined that all iron resources be nominated under the iron industry property type, rather than to establish artificial divisions between industrial and community components.

It was decided that as part of the first phase, a context on the steel industry would be completed to 1945. As part of the second-phase nomination of steel sites, the context would be extended from 1945 to the present, and a property type(s) developed for steel mills and steel communities.



United States Department of the Interior  
National Park Service

**National Register of Historic Places  
Continuation Sheet**

Iron and Steel Resources of Pennsylvania, 1716-1945

H 1

Section number \_\_\_\_\_ Page \_\_\_\_\_

---

BIBLIOGRAPHY

PUBLISHED BOOKS AND MONOGRAPHS

- Agricola, Georgius. De Re Metallica. Translated by Herbert Clark Hoover and Lou Henry Hoover. London: The Mining Magazine, 1912; reprint ed., New York: Dover Publications, Inc., 1950.
- Aitchison, Leslie. A History of Metals. London: MacDonald and Evans, 1960.
- American Iron and Steel Institute. Iron and Steel Works of the United States. Philadelphia, 1886.
- American Iron and Steel Institute. Iron and Steel Works of the United States and Canada. New York, 1930.
- Bartholomew, Craig L. and Metz, Lance E. The Anthracite Iron Industry of the Lehigh Valley. Easton, Pa.: Hugh Moore Historical Park and Museums, Inc., 1988.
- Bining, Arthur C. British Regulation of the Colonial Iron Industry. Philadelphia: University of Pennsylvania Press, 1933.
- Bining, Arthur C. "Early Ironmasters of Pennsylvania." Pennsylvania History, vol. 18, no. 2, April 1951; reprint, Harrisburg: Pennsylvania Historical and Museum Commission, 1951.
- Bining, Arthur C. Pennsylvania Iron Manufacture in the Eighteenth Century. 2nd ed. Harrisburg: Pennsylvania Historical and Museum Commission, 1987.
- Bining, Arthur C. Pennsylvania's Iron and Steel Industry. Pennsylvania History Studies, no. 5. Gettysburg: The Pennsylvania Historical Association, 1954.
- Bodnar, John. Immigration and Industrialization: Ethnicity in an American Mill Town, 1870-1940. Pittsburgh: University of Pittsburgh Press, 1977.
- Brody, David. Steelworkers in America: The Nonunion Era. New York: Russell and Russell, 1960.

United States Department of the Interior  
National Park Service

National Register of Historic Places  
Continuation Sheet

Iron and Steel Resources of Pennsylvania, 1716-1945

H 2

Section number \_\_\_\_\_ Page \_\_\_\_\_

---

- Chandler, Alfred D., Jr. The Visible Hand: The Managerial Revolution in American Business. Cambridge: Harvard University Press, 1977.
- Clark, Victor S. History of Manufactures in the United States. New York: Peter Smith, 1949 reprint of 1929 edition.
- Convention of Iron Masters. Documents Relating to the Manufacture of Iron, Published on Behalf of the Convention of Iron Masters which Met in Philadelphia on the 20th of December, 1849. Philadelphia, 1850.
- Current, Richard N., Williams, T. Harry and Freidel, Frank. American History, A Survey. 4th ed. Vol. 1: To 1877. New York: Alfred A. Knopf, 1975.
- DiOrio, Eugene L. Remarkable Past-Promising Future: Lukens, 1910-1985. Phoenixville, Pa.: Lukens Corporate Public Relations Division, 1985.
- Dulles, Foster Rhea, and Dubofsky, Melvyn. Labor in America: A History. Arlington Heights, Ill.: Harlan Davidson, 1984.
- Fitch, John A. The Steel Workers. New York: New York Charities Publication Committee, 1911.
- Fitzsimons, Gray, ed. Blair County and Cambria County, Pennsylvania: An Inventory of Historic Engineering and Industrial Sites. Washington, D.C.: U.S. Department of the Interior, 1990.
- Gale, W. K. V. Iron and Steel. Industrial Archaeology Series, L. T. C. Rolt, gen. ed. London: Longmans and Green Co. Ltd., 1969.
- Grace, Eugene G. Charles M. Schwab. n.p., 1947.
- Hessen, Robert. Steel Titan: The Life of Charles M. Schwab. New York: Oxford University Press, 1975.
- Hogan, William T. Economic History of the Iron and Steel Industry in the United States. Vols. 1-5, Lexington, Mass.: Lexington Books, 1971.
- Klein, Philip S. and Hoogenboom, Ari. A History of Pennsylvania. 2nd ed. University Park: Pennsylvania State University Press, 1980.
- Knauth, Percy. The Metalsmiths. The Emergence of Man Series. New York: Time-Life Books, 1974.

United States Department of the Interior  
National Park Service

**National Register of Historic Places  
Continuation Sheet**

Iron and Steel Resources of Pennsylvania, 1716-1945

H 3

Section number \_\_\_\_\_ Page \_\_\_\_\_

---

Lauderbaugh, Richard A. American Steel Makers and the Coming of the Second World War. Ann Arbor: UMI Research Press, 1980.

McCurdy, Linda. The Potts Family Iron Industry in the Schuylkill Valley. Ph.D. dissertation, The Pennsylvania State University, 1974; pub. Pottstown, Pa.: Pottstown Historical Society, 1975.

Miller, E. Willard. Pennsylvania: Keystone to Progress. Northridge, Calif.: Windsor Publications, Inc., 1986.

Mulholland, James A. A History of Metals in Colonial America. University, Al.: The University of Alabama Press, 1981.

Overman, Frederick. The Manufacture of Iron in all its Various Branches. Philadelphia: Henry C. Baird, 1854.

Paskoff, Paul F. Industrial Evolution: Organization, Structure, and Growth of the Pennsylvania Iron Industry, 1750-1860. Baltimore: The Johns Hopkins University Press, 1983.

Sharp, Myron B. and Thomas, William H. A Guide to the Old Stone Blast Furnaces in Western Pennsylvania. Pittsburgh: The Historical Society of Western Pennsylvania, 1966.

Stevens, Sylvester K. Pennsylvania, Titan of Industry. New York: Lewis Historical Publishing Co., 1948.

Swank, James M. History of the Manufacture of Iron in All Ages. reprint, American Classics of History and Social Science, Series 6. New York: Burt Franklin, 1968.

Temin, Peter. Iron and Steel in Nineteenth Century America, An Economic Inquiry. Cambridge, Mass.: The M.I.T. Press, 1964.

United States Census Office. Fifteenth Census, Manufactures. Washington, D.C.: United States Government Printing Office, 1933, Vol. 2.

United States Census Office. Ninth Census: The Statistics of the Wealth and Industry of the United States. Washington, D.C.: 1872.

United States Census Office. Sixteenth Census of the United States, Manufactures: 1939. Washington, D.C.: Government Printing Office, Volume 2, Part 2.

United States Department of the Interior  
National Park Service

**National Register of Historic Places  
Continuation Sheet**

Iron and Steel Resources of Pennsylvania, 1716-1945

H 4

Section number \_\_\_\_\_ Page \_\_\_\_\_

---

United States Census Office. Twelfth Census of the United States Taken in the Year 1900: Manufactures. Washington, D.C.: Government Printing Office, 1902, Vol. 11, part 4.

Wall, Joseph Frazier. Andrew Carnegie. New York: Oxford University Press, 1970.

Warren, Kenneth. The American Steel Industry, 1850-1970: A Geographical Interpretation. Oxford: Clarendon Press, 1973.

Yetter, John. Steelton, Pennsylvania: Stop, Look, Listen. Harrisburg: Triangle Press, 1979.

PUBLISHED ARTICLES

Bining, Arthur C. "The Rise of Iron Manufacture in Western Pennsylvania." The Western Pennsylvania Historical Magazine. vol. 16, no. 4 (November 1933): 235-256.

Chandler, Alfred D., Jr. "Anthracite Coal and the Beginnings of the Industrial Revolution in the United States." Business History Review. vol. 46, no. 2 (Summer 1972): 141-181.

"The Grey Structural Mill at South Bethlehem." The Iron Age. (January 2, 1908).

Habecker, Jan Margut. "A Dynasty Tumbles." Pennsylvania Heritage. vol. 13, no. 1 (Winter 1987): 10-15.

Hunter, Louis C. "Influence of the Market upon Technique in the Iron Industry in Western Pennsylvania up to 1860." Journal of Economic and Business History. vol. 1 (1928-1929; reprint, New York: Kraus Reprint Corporation, 1964): 241-281.

Kallmann, Diane. "Steel on the Susquehanna." Pennsylvania Heritage (Summer, 1990): 33-34.

Woodridge, C.L. "Industrial Housing." Yearbook of the American Iron and Steel Institute (1922).

Yates, W. Ross. "Discovery of the Process for Making Anthracite Iron." The Pennsylvania Magazine of History and Biography. vol. 98, no. 2 (April 1974): 206-223.

**United States Department of the Interior  
National Park Service**

**National Register of Historic Places  
Continuation Sheet**

Iron and Steel Resources of Pennsylvania, 1716-1945

H 5

Section number \_\_\_\_\_ Page \_\_\_\_\_

---

UNPUBLISHED MANUSCRIPTS

Evans, June. "Chickies Rock Park Industrial Survey: Data Analysis Report and Final Report." Submitted to the Lancaster County Board of Commissioners, Lancaster County, Pa., 1990.

Evans, June. "Industrial Archaeology Sites in the Chickies Rock Park Floodplain." Unpublished site tour booklet, April 1991.

Historic Resource Survey Forms for Electric Reduction Company, Washington County, Latrobe Electric Steel Company, Westmoreland County, and Shenango Furnace Company, Allegheny County, prepared by Walter Kidney and Earl James, June 1987, on file at the Bureau for Historic Preservation, Harrisburg, Pennsylvania.

Misa, Thomas Jay. "Science, Technology and Industrial Structure: Steelmakers in America, 1870-1925." Ph.D. Dissertation, University of Pennsylvania, 1987.

Sabadasz, Joel. National Historic Landmark nomination for Duquesne blast furnace number 1, Carrie Furnaces, and Edgar Thomson Furnaces, draft manuscript, 1990.

Sanborn Map Company, New York, 1875 and 1896, maps of Steelton, Pennsylvania

Suciu, Deborah. "Historic Industrial Resources of Huntingdon County." National Register Nomination, Pennsylvania Historical and Museum Commission, 1989.

MANUSCRIPT COLLECTIONS

Papers of the Bethlehem Steel Corporation, Acc. 1699, Hagley Library, Wilmington, Delaware

Papers of the Phoenix Iron Company, Acc. 916, Hagley Museum and Library, Wilmington, Delaware.

Manuscript Group 214, Pennsylvania State Archives, Harrisburg, Pennsylvania